

AUTOMATION PRODUCTS GROUP, INC.

Operator's Manual

FLX Series

Magnetic Float Sensors

9003283
Rev. C4, 10/09



Automation Products Group, Inc.

APG...Providing tailored solutions for measurement applications

Tel: 1/888/525-7300 • Fax: 1/435/753-7490 • www.apgsensors.com • E-mail: sales@apgsensors.com

Table of Contents

Warranty 3
Description 4
Installation 5-6
Wiring 7-8
Circuit Protection 9
Inspection & Maintenance 10
Technical Notes 10
Specifications 11
Certificate of Compliance 12-14



• Warranty and Warranty Restrictions

APG warrants its products to be free from defects of material and workmanship and will, without charge, replace or repair any equipment found defective upon inspection at its factory, provided the equipment has been returned, transportation prepaid, within 24 months from date of shipment from factory.

THE FOREGOING WARRANTY IS IN LIEU OF AND EXCLUDES ALL OTHER WARRANTIES NOT EXPRESSLY SET FORTH HEREIN, WHETHER EXPRESSED OR IMPLIED BY OPERATION OF LAW OR OTHERWISE INCLUDING BUT NOT LIMITED TO ANY IMPLIED WARRANTIES OF MERCHANTABILITY OR FITNESS FOR A PARTICULAR PURPOSE.

No representation or warranty, express or implied, made by any sales representative, distributor, or other agent or representative of APG which is not specifically set forth herein shall be binding upon APG. APG shall not be liable for any incidental or consequential damages, losses or expenses directly or indirectly arising from the sale, handling, improper application or use of the goods or from any other cause relating thereto and APG's liability hereunder, in any case, is expressly limited to the repair or replacement (at APG's option) of goods.

Warranty is specifically at the factory. Any on site service will be provided at the sole expense of the Purchaser at standard field service rates.

All associated equipment must be protected by properly rated electronic/ electrical protection devices. APG shall not be liable for any damage due to improper engineering or installation by the purchaser or third parties. Proper installation, operation and maintenance of the product becomes the responsibility of the user upon receipt of the product.

Returns and allowances must be authorized by APG in advance. APG will assign a Return Material Authorization (RMA) number which must appear on all related papers and the outside of the shipping carton. All returns are subject to the final review by APG. Returns are subject to restocking charges as determined by APG's "Credit Return Policy".

• Description

The FLX series instruments contain reed switches in the stem and permanent magnets in the floats. As the float rises or falls with the level of the liquid, the magnet inside the float act on the reed switch inside the stem to provide the SPST switching action.

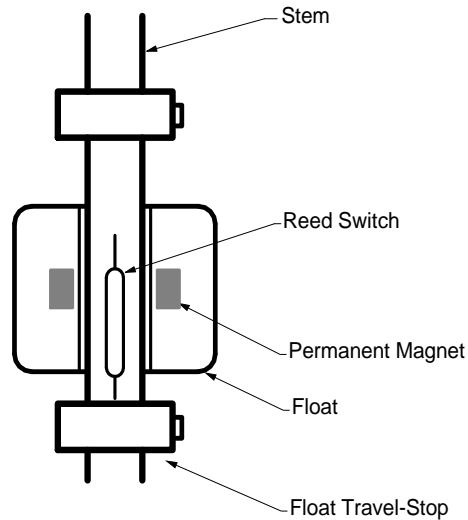

• Handling of the Explosion-Proof FLX Series

The FLX is rated CSA Class 1 Division 1; Groups C, D for explosive environments. All repairs and adjustments of the FLX must be made by the factory. To modify, disassemble, or alter the FLX on site is strictly prohibited. Do not loosen any joints, with the exception of the housing cover for electrical connection.

• Installation

- Unpacking -

When unpacking the instrument, exercise care not to subject the instrument to mechanical shock. After unpacking, visually inspect the instrument for damage.

- Environment -

The FLX series sensors should be installed indoors or outdoors in an area which meets the following conditions:

1. The ambient temperature does not exceed -40°F to +185°F (-40°C to 85°C).
NOTE: It is recommended that a sun shield be installed over the housing if exposed to direct sunlight.
2. The medium temperature does not exceed -40°F to +185°F (-40°C to 85°C).
3. Relative humidity up to 100%
4. Pollution Degree 2
5. Measurement Category II
6. Altitude 2000 m or less.
7. Locate the sensor away from strong magnetic fields such as those produced by motors, transformers, solenoid valves, etc.
8. The medium is free from metallic substances and other foreign matter.
9. No corrosive gases such as NH₃, SO₂, Cl₂, etc.
10. No excessive vibration
11. Ample space for maintenance and inspection.

• Installation

- Location -

Do not locate the FLX series sensor near inlets/outlets.

If there is surface wave action, then use a time-delay relay or stilling tube. If a stilling tube is used, drill vent holes in the tube and use a spacer to assure the float has free travel inside the tube.

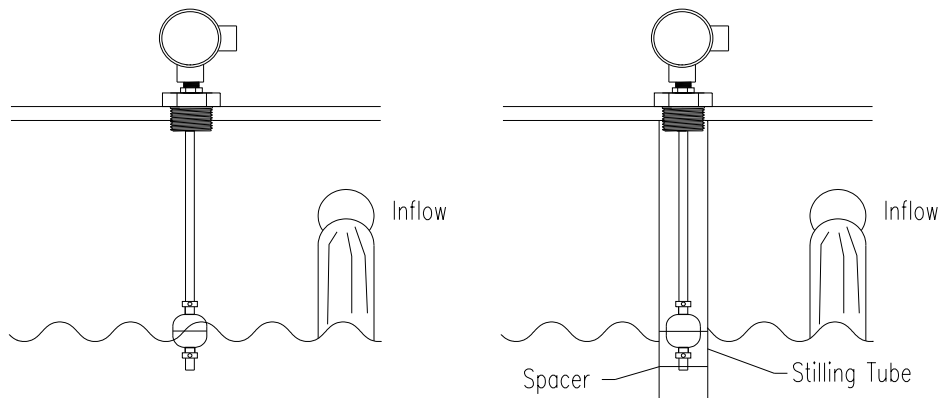

Wave action may cause switch to chatter.

Use a stilling tube or time-delay relay to prevent switch chatter.

- Mounting -

The FLX can be mounted up to 30° from vertical.

1. Flange Mounting

Provide the compatible mating flange on the tank and install using a suitable gasket.

2. Plug Mounting

Provide the compatible female boss on the tank and install the FLX with a suitable gasket, O-ring, or thread tape.



Automation Products Group, Inc.
 APG...Providing tailored solutions for measurement applications

• **Wiring**

Installation in Class I Division 2 Groups C and D, Max. Temp. 85°C
 Installation in Class I Division 1 Groups C and D, Max. Temp. 40°C

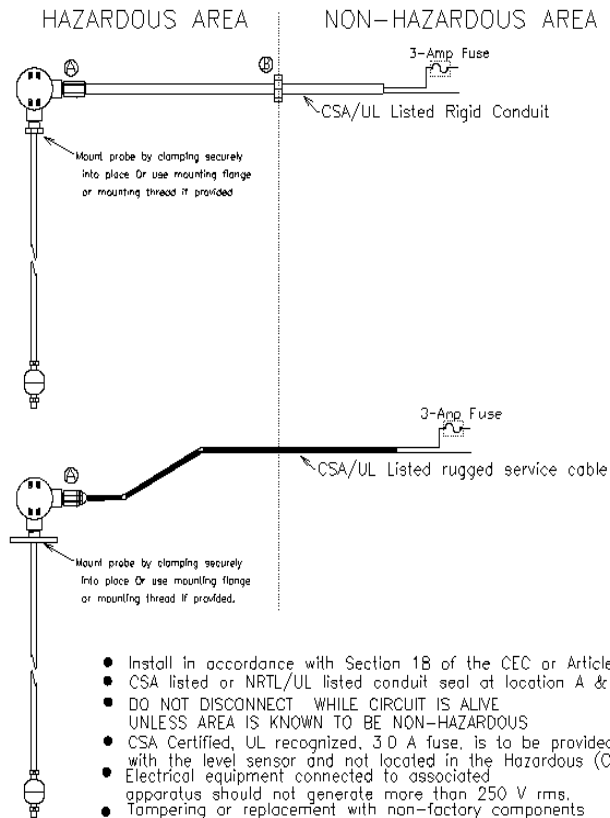

- Install in accordance with Section 1B of the CEC or Article 500 of the NEC
- CSA listed or NRTL/UL listed conduit seal at location A & B.
- DO NOT DISCONNECT WHILE CIRCUIT IS ALIVE UNLESS AREA IS KNOWN TO BE NON-HAZARDOUS
- CSA Certified, UL recognized, 30 A fuse, is to be provided in series with the level sensor and not located in the Hazardous (Classified) Location.
- Electrical equipment connected to associated apparatus should not generate more than 250 V rms.
- Tampering or replacement with non-factory components may adversely affect the safe use of the system.

<p>PROPRIETARY AND CONFIDENTIAL THIS DRAWING IS THE PROPERTY OF AUTOMATION PRODUCTS GROUP, INC. LOGAN, UTAH AND MAY NOT BE USED, REPRODUCED, PUBLISHED, OR DISCLOSED TO OTHERS WITHOUT WRITTEN CONSENT OF THE COMPANY. IF LOANED, IT IS SUBJECT TO RETURN UPON DEMAND AND MAY NOT BE USED IN ANY WAY DIRECTLY OR INDIRECTLY DETRIMENTAL TO THE COMPANY.</p> <p>Form 885B2 Rev. B</p>	<p>UNLESS OTHERWISE SPECIFIED DIMENSIONS ARE IN INCHES AND TOLERANCES ARE AS FOLLOWS: TOLERANCE ON ANGLES: ±1° 2 PLACES: ±.01" 3 PLACES: ±.005" INTERPRET DIMENSIONS AND TOLERANCES PER ASME Y14.5M 1994 (R1999)</p>	<p>APPROVALS</p> <p>DESIGN: K. Reid 10/10/00</p> <p>DRAW: T. Brungton 10/10/00</p> <p>APPV: K. Reid 10/10/00</p>	<p>DATE</p>	<p>APG 1225 West 1700 North Logan, Utah 84304 888.528.7300</p> <p>FLX Hazardous Mounting Drawing Magnetic Float Drawing (FLX_HM)</p>			
		<p>THIRD ANGLE PROJECTION</p>	<p>CONTRACT</p>		<p>DATE</p>		
		<p>MATERIALS</p> <p>N/A</p>	<p>DATE</p>		<p>REV</p> <p>C 02450</p>	<p>ISSUE NO</p> <p>FLX_HM 9003281</p>	<p>REV</p> <p>C1</p>
		<p>FINISH</p> <p>N/A</p>	<p>SCALE</p> <p>NONE</p>		<p>DO NOT SCALE DRAWING</p>	<p>SHEET 1 OF 1</p>	

• **Wiring**

- Wiring for 1 to 4 switches

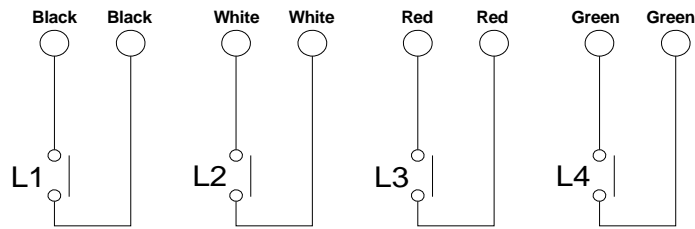

- Wiring for greater than 4 switches

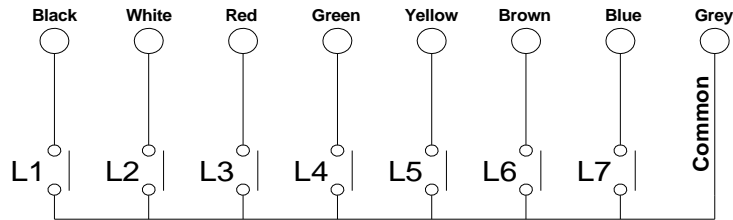

Number of Levels	Wiring Color							
	L1	L2	L3	L4	L5	L6	L7	Com.
L1	Blk x 2							
L2	Blk x 2	Wh x 2						
L3	Blk x 2	Wh x 2	Red x 2					
L4	Blk x 2	Wh x 2	Red x 2	Grn x 2				
L5	Black	White	Red	Green	Yellow			Grey
L6	Black	White	Red	Green	Yellow	Brown		Grey
L7	Black	White	Red	Green	Yellow	Brown	Blue	Grey

• **Circuit Protection**

WARNING!

DO NOT EXCEED CONTACT RATINGS! When an inductive load is used (e.g. a motor, a coil, or an electromagnetic relay), a back electromotive force of several hundred volts (energy stored in the inductance) arises when the contacts are opened. This results in considerable decrease in contact life. The same result arises even when a resistive load is used with a high voltage or a large current. The figures below show circuits for protecting the reed switch(s) from the back electromotive force.

Protecting Circuit Using Diode

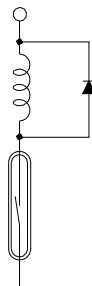

Protecting Circuit Using Varistor

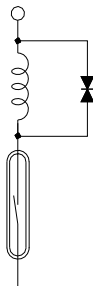

Protecting Circuit Using CR

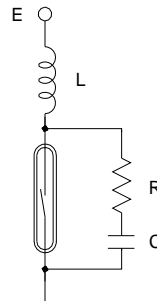

$$C = \frac{L^2}{10} \text{ (}\mu\text{F)}$$

$$R = \text{Approx. } \frac{E}{10 \times I (1 + 50/E)}$$

Code A & B Switches

Max. contact capacity	70 VAAC,
Max. switching current	220 VAC 0.5 A, 120 VDC 0.5 A

Code C Switches

Max. contact capacity	110 VAAC,
Max. switching current	220 VAC 0.5 A, 115 VDC 0.5 A

- **Inspection and Maintenance**

Periodic inspection is necessary to keep your FLX unit in good working order.

CAUTION! Do not remove the housing cover until the atmosphere is determined to be safe, and the power supplied to the unit is turned off.

1. Keep the sensor clean.

Never leave the housing cover off. If the cover becomes damaged or is misplaced, order a replacement immediately.

If sediment or other foreign matter is trapped between the stem and the float, detection errors may be caused. Keep the float and stem clean.

2. Inspect the switches and terminals.

- **Technical Notes**

1. The float travel stop settings are based on how the magnetic field influences the reed switch. Normally it is not necessary to move the stop. If the stops are moved, check the switch action for float overrun.
2. Normally Open (NO) (switch closes as level rises) and Normally Closed (NC) (switch closes as level falls).

- **FLX Specifications**

Maximum Number Switching Points:	7
Resolution:	+/- 1/16" (2mm)
Field Adjustable Actuation Levels:	No
Maximum Length:	153 in.
Process Temperature:	Class 1 Div. 2 Applications: -40 ^o to +185 ^o F (-40 ^o to +85 ^o C) Class 1 Div. 1 Applications: -40 ^o to +140 ^o F (-40 ^o to +40 ^o C)
Housing Material:	Die Cast Aluminium
CSA Rating:	Class 1 Div. 1 Groups C, D
Housing Rating:	NEMA 4
Contact Rating:	
<i>Code A & B Switch</i>	
Max. contact capacity:	70 VA AC,
Max. switching current:	220 VAC 0.5 A, 120 VDC 0.5 A
<i>Code C Switch</i>	
Max. contact capacity:	110 VA AC,
Max. switching current:	220 VAC 0.5 A, 115 VDC 0.5 A



Certificate of Compliance

Certificate: 2167400	Master Contract: 237484
Project: 2167400	Date Issued: 2009/11/16
Issued to: Automation Products Group Inc 1025 West 1700 North Logan, UT 84321 USA Attention: Karl Reid	

The products listed below are eligible to bear the CSA Mark shown with adjacent indicators 'C' and 'US' for Canada and US or with adjacent indicator 'US' for US only or without either indicator for Canada only.



Issued by: Frank Gessner

Authorized Patricia Pasemko, Operations
by: Manager

PRODUCTS

CLASS 2252 05 - PROCESS CONTROL EQUIPMENT
CLASS 2252 85 - PROCESS CONTROL EQUIPMENT - Certified to US Standards

Float Level Sensors, permanently connected, indoor and outdoor use, max. operating ambient 85°C:

- Models FLXx and FLRx, rated 220 V, 0.5 A;
- Models RPMx, RPXx and RPEx, rated 5 - 15 Vdc, 100 mA, or 12 to 24 Vdc, 4-20mA;
- Model RPAx, rated 12 to 24 Vdc, 4-20mA;
- Model CTR-0100 (P/Ns 110101 and 110101-0001), Loop Powered 4-20mA Module, rated 4-20mA output is 12 to 24 Vdc.

Note: The above models are Pollution Degree 2, Measurement Category II.

Notes for Models FLXx, FLRx, RPMx, RPAx, RPXx, RPEx:

DQD 507 Rev. 2009-09-01



Automation Products Group, Inc.
APG...Providing tailored solutions for measurement applications



Certificate:	2167400	Master Contract:	237484
Project:	2167400	Date Issued:	2009/11/16

1. The "x" in the Model designations may be any alpha-numeric character, to denote minor mechanical options, not affecting safety. Refer to Illustration 28 for Model designator and suffix details.
2. The equipment is intended to be installed as required by the applicable electrical code (CEC, NEC) and as specified by the manufacturer's Installation Instructions.
3. The circuit board P/N STF-CTR-01** from the Model RPMx Probe may be supplied as a component part where the suitability of the final installation will be inspected by the authority with jurisdiction in the area where installed.
4. The installation will be inspected by the authority with jurisdiction in the area where installed.

CLASS 2258 02 - PROCESS CONTROL EQUIPMENT - FOR HAZARDOUS LOCATIONS

CLASS 2258 82 - PROCESS CONTROL EQUIPMENT - FOR HAZARDOUS LOCATIONS, U.S. Requirements

Class I, Division 1, Groups C, and D

- Float Level Sensors, model FLXx, rated 220 V, 0.5 A, max., and model RPMx and RPXx, rated 5 - 15 Vdc, 100mA or 12 to 24 Vdc, 4-20mA; operating ambient 40°C.

Notes for Models FLXx, RPMx, RPXx:

1. The "x" in the Model designations may be any alpha-numeric character, to denote minor mechanical options, not affecting safety.
2. The equipment is intended to be installed as required by the applicable electrical code (CEC, NEC) and as specified by the manufacturer's Installation Instructions.
3. The installation will be inspected by the authority with jurisdiction in the area where installed.

Class I, Division 2, Groups C, and D

- Float Level Sensor model FLXx, rated 220 V, 0.5 A, model RPMx and RPXx, rated 5 - 15 Vdc, 100mA, or rated 12 to 24 Vdc, 4-20mA, and model RPAX, rated 12 to 24 Vdc, 4-20mA, max; operating ambient 85°C.

Notes for Models FLXx, RPMx, RPAX, RPXx:

1. The "x" in the Model designations may be any alpha-numeric character, to denote minor mechanical options, not affecting safety.
2. The equipment is intended to be installed as required by the applicable electrical code (CEC, NEC) and as specified by the manufacturer's Installation Instructions.
3. The installation will be inspected by the authority with jurisdiction in the area where installed.

DQD 507 Rev. 2009-09-01



Certificate: 2167400

Master Contract: 237484

Project: 2167400

Date Issued: 2009/11/16

CLASS 2258 03 - PROCESS CONTROL EQUIPMENT - INTRINSICALLY SAFE AND NON INCENDIVE SYSTEMS - FOR HAZARDOUS LOCATIONS

CLASS 2258 83 - PROCESS CONTROL EQUIPMENT - INTRINSICALLY SAFE AND NON INCENDIVE SYSTEMS - FOR HAZARDOUS LOCATIONS, CERTIFIED TO U.S. STANDARDS

Class I, Division 2, Groups C, and D

- Float Level Sensor model RPMx and RPXx, rated 5 - 15 Vdc, 100mA, or rated 12 to 24 Vdc, 4-20mA, and model RPAX, rated 12 to 24 Vdc, 4-20mA; max; operating ambient 85°C. Field wiring is non-incendive when installed per drawings 9001415, 9001932 and 9002023 respectively.

Notes for Models RPMx, RPAX, RPXx:

1. The "x" in the Model designations may be any alpha-numeric character, to denote minor mechanical options, not affecting safety.
2. The equipment is intended to be installed as required by the applicable electrical code (CEC, NEC) and as specified by the manufacturers Installation Instructions.
3. The installation will be inspected by the authority with jurisdiction in the area where installed.

CLASS 2258 04 - PROCESS CONTROL EQUIPMENT - INTRINSICALLY SAFE, ENTITY - FOR HAZARDOUS LOCATIONS

CLASS 2258 84 - PROCESS CONTROL EQUIPMENT - INTRINSICALLY SAFE, ENTITY - FOR HAZARDOUS LOCATIONS, U.S. Requirements

Class I, Division 1, Groups C, and D

- Float Level Sensors, model RPMx, RPAX, RPXx and model CTRx loop powered 24Vdc, 4-20mA converter module, max. operating ambient 85°C; Temperature Code rating T3C; Intrinsically Safe when connected as per drawing 9001414, 9001423 and 9001930 with the following Entity Parameters: $V_{max} = 30V$, $I_{max} = 130mA$, $C_i = 3nF$, $L_i = 0uH$.

Notes for Models RPMx, RPAX and RPXx:

1. The "x" in the Model designations may be any alpha-numeric character, to denote minor mechanical options, not affecting safety.
2. The equipment is intended to be installed as required by the applicable electrical code (CEC, NEC) and as specified by the manufacturers Installation Instructions.
3. The installation will be inspected by the authority with jurisdiction in the area where installed.

APPLICABLE REQUIREMENTS

CSA Standards C22.2 No. 0-M91 - General Requirements - Canadian Electrical Code, Part II

DQD 507 Rev. 2009-09-01



Automation Products Group, Inc.

APG...Providing tailored solutions for measurement applications



Certificate: 2167400

Master Contract: 237484

Project: 2167400

Date Issued: 2009/11/16

CSA Standards C22.2 No. 30-M1987 - Explosion-Proof Enclosures for Use in Class I Hazardous Locations

CAN/CSA C22.2 No. 61010-1-04 - Safety Requirements for Electrical Equipment for Measurement, Control, and Laboratory Use, Part 1: General Requirements

CSA Standards C22.2 No. 157-M1992 - Intrinsically Safe and Non-Incendive Equipment for Use in Hazardous Locations

CSA Standards C22.2 No. 213-M1987 - Non-Incendive Electrical Equipment for Use in Class I, Division 2 Hazardous Locations

UL 61010-1 (2nd Edition) - Safety Requirements for Electrical Equipment for Measurement, Control, and Laboratory Use - Part 1: General Requirements

UL 913, Sixth Edition - Intrinsically Safe Apparatus and Associated Apparatus for use in Class I, II, III, Division 1, Hazardous (Classified) Locations

UL1203, Third Edition - Explosion-Proof and Dust-Ignition-Proof Electrical Equipment for Use in Hazardous (Classified) Locations

FM 3611, December 2004 - Nonincendive Electrical Equipment for Use in Class I and II, Divisions 1 and 2 Hazardous (Classified) Locations

TIL E-11 - Enclosures of Welded Construction for Class I, Division 1, Hazardous Locations appended to the applicable requirements

DQD 507 Rev. 2009-09-01

AUTOMATION

PRODUCTS
GROUP, INC.

***APG...Providing tailored solutions
for measurement applications***



Automation Products Group, Inc.

Tel: 1/888/525-7300

1/435/753-7300

Fax: 1/435/753-7490

e-mail: sales@apgsensors.com

www.apgsensors.com

Automation Products Group, Inc.

1025 W. 1700 N.

Logan, UT 84321