



# N2020 Controller

## TEMPERATURE CONTROLLER – INSTRUCCIONS MANUAL – V1.0x D

### SAFETY ALERTS

The symbols below are used on the equipment and throughout this document to draw the user's attention to important operational and safety information.

<b>CAUTION:</b> Read the manual thoroughly before installing and operating the equipment.	<b>CAUTION OR DANGER:</b> Electrical shock hazard

All safety related instructions that appear in the manual must be observed to ensure personal safety and to prevent damage to either the instrument or the system. If the instrument is used in a manner not specified by the manufacturer, the protection provided by the equipment may be impaired.

### INSTALLATION / CONNECTIONS

The controller must be fastened on a panel, following the sequence of steps described below:

- Prepare a panel cut-out of 45 x 93 mm;
- Remove the mounting clamps from the controller;
- Insert the controller into the panel cut-out;
- Slide the mounting clamp from the rear to a firm grip at the panel.

### ELECTRICAL CONNECTIONS

The controller complete set of features is drawn in **Fig. 01**:

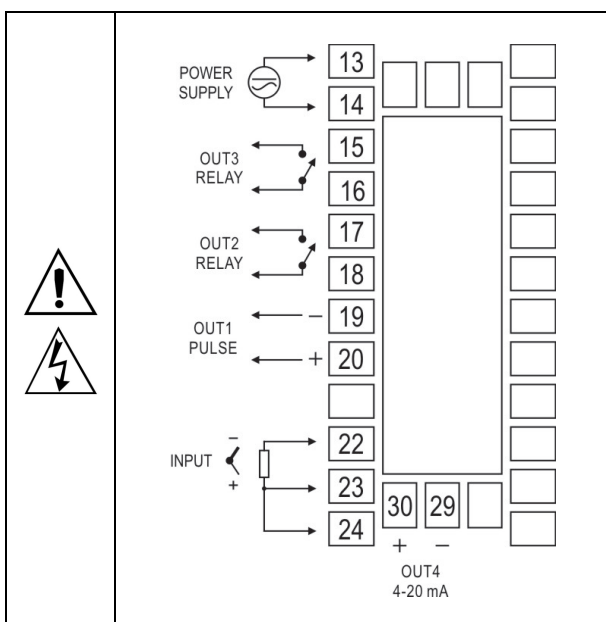

**Fig. 01** - Input connections, outputs and power supply

### RECOMMENDATIONS FOR THE INSTALLATION

- Leads of input signals may travel the plant, separately of output and feeding leads, if is possible in grounded conduits.
- All electronic instruments must be powered by a clean mains supply, proper for instrumentation.
- It is strongly recommended to apply RC'S FILTERS (noise suppressor) to contactor coils, solenoids, etc.

### FEATURES

#### INPUT TYPE SELECTION

The input type to be used by the controller is defined in the equipment settings. **Table 01** shows the input options available for the user, one of them must be selected during the controller setting.

TYPE	CODE	RANGE OF MEASUREMENT
Thermocouple J	<b>tc J</b>	Range: -110 to 950 °C (-166 to 1742 °F)
Thermocouple K	<b>tc K</b>	Range: -150 to 1370 °C (-238 to 2498 °F)
Thermocouple T	<b>tc T</b>	Range: -160 to 400 °C (-256 to 752 °F)
<b>Pt100</b>	<b>Pt</b>	Range: -200 to 850 °C (-328 to 1562 °F)

**Table 01** – Inputs types

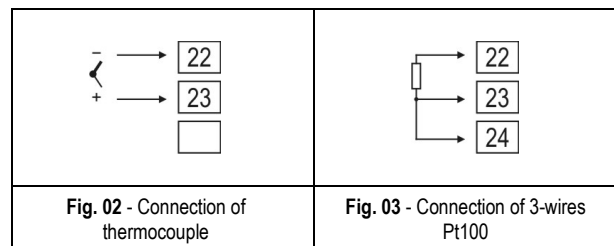

Notes:

- 1- The specification of controller accuracy does not consider the error showed by the temperature sensor used.
- 2- Suitable extension cables must be used with thermocouples.
- 3- In order to use 2-wire Pt100 thread, connect 23 and 24 terminals. The sensor must be connected between 22 and 23 terminals. If the sensor is 4-wired, keep one of the wires disconnected close to the controller. The wires used must always have the same section (same gauge).

### OUTPUTS

The controller offers two, three or four output channels, depending on the loaded optional features. Those channels are configured by the user to act as control outputs, alarm outputs, LBD Function or PV or SP retransmission.

- OUT1** - Logical pulse, 5 Vdc / 25 mA  
Available at terminals 19 and 20 of controller
- OUT2** - Relay SPST-NA  
Available at terminals 17 and 18 of controller
- OUT3** - Relay SPST-NA  
Available at terminals 15 and 16 of controller

**OUT4 -** Analog output:  
 Electrical current, 0-20 mA or 4-20 mA  
 Electrical voltage pulse, 10 Vdc / 20 mA  
 Available at 29 and 30 terminals of controller

**CONTROL OUTPUT**

It is the output channel which effectively actuates on the process. Main exit.

**ALARM OUTPUT**

Output channels which actuates on the protection and signalization of process condition.

**RUN FUNCTION**

RUN parameter (*run*) works as a main key of output channels of controller. It enables channels defined as control output and channels defined as alarm output. With **YES** in this parameter, the control and alarm outputs are able to operate, turning on / off, according to the controller's determinations. With **NO**, all outputs remain off, regardless of the process requirements. In this condition, the controller's display starts to show the **STOP** message, alternately with the measured temperature value (PV).

This function can also be obtained by the **F** key when configured to operate in such mode.

**AUTOMATIC CONTROL MODE**

The controller may act in two different modes of operation: **Automatic** mode or **Manual** mode.

In automatic mode, the controller determines the control output behavior in order to lead the process up to the defined value in SP. It determines the duration the control output remains on and off, balancing the energy quantity applied to the process. In a technical language: it determines the MV value (Manipulated Variable). This is the normal mode of the controller operation.

The parameter "**Ctrl**" defines the control mode to be adopted:

- Auto** for automatic control.
- Man** for manual control.

This exchange functionality between automatic and manual mode can also be obtained by the key, when configured to operate in such mode.

The period (PWM cycle period) is defined in Cycle time parameter (**Ct**). In it, a time interval (seconds), is defined and considered as a reference for the determination of MV.

For instance: For a 10 seconds interval ((t = 10), 20 % MV means output on for 2 seconds and off for 8 seconds, balancing the energy quantity applied to the process.

**MANUAL CONTROL MODE**

In the manual mode, is the user who determines the control output behavior. It defines the MV value, this value will not be interfered by the controller.

By exchanging the automatic mode to manual mode, the value adopted for MV will be the last value defined automatically by the controller. It is known as "bumpless transfer".

**ON-OFF CONTROL / PID CONTROL**

In the automatic mode, it acts with ON-OFF adjustable hysteresis control and also with the PID control with the automatic tuning resource.

**ALARM OUTPUT**

The controller has two alarms which may be directed for any of the output channels. These alarms can be configured to operate the different functions described on **Table 02**.

<b>oFF</b>	Alarms turned off.	
<b>Lo</b>	Alarm of Absolute Minimum Value. Triggers when the value of measured PV is <b>below</b> the value defined for alarm Setpoint (SPA1 or SPA2).	
<b>Hi</b>	Alarm of Valor Absolute Maximum Value. Triggers when the value of measured PV is <b>above</b> the value defined for alarm Setpoint.	
<b>dIF</b>	Alarm of Differential Value. In this function the parameters <b>SPA1</b> and <b>SPA2</b> represent the deviation of PV in relation to the SP of CONTROL.	
	SPA1 positive	SPA1 negative
<b>dIFL</b>	Alarm of Minimum Differential Value. It triggers when the value of PV is <b>below</b> the defined point by (using the Alarm 1 as example):	
	SPA1 positive	SPA1 negative
<b>dIFH</b>	Alarm of Valor Maximum Differential Value. Triggers when the value of PV is <b>above</b> the defined point by (using Alarm 1 as example):	
	SPA1 positive	SPA1 negative
<b>iErr</b>	Sensor Break Alarm. Activated when the input signal of PV is interrupted, out of the range limits or Pt100 in short-circuit.	
<b>r5</b>	Program Segment Alarms. It acts when a certain segment of the ramps and soaks programs is reached. The respective segment is defined on the creation of ramps and soaks programs.	

**Table 02 – Alarme functions**

**Note:** Alarm functions on **Table 02** are also valid for Alarm 2 (SPA2).

**INITIAL BLOCKING OF ALARM**

The **initial blocking** option inhibits the alarm from being recognized if an alarm condition is present when the controller is first energized (or after a transition from run YES or NO). The alarm will be enabled only after the occurrence of a non-alarm condition followed by a new occurrence for the alarm.

The initial blocking is useful, for instance, when one of the alarms is configured as a minimum value alarm, causing the activation of the alarm soon upon the process start-up, an occurrence that may be undesirable.

The first lock out is not valid for **iErr** function (Open Sensor).

**PV AND SP ANALOGICAL RETRANSMISSION**

The analogical output, **OUT4**, when available, may perform the retransmission of PV or SP values, with 0-20 mA or 4-20 mA signs. The analogical retransmission is scalable, i.e., it has minimum and maximum limits, which define the output range, defined in **rELL** and **rEHL** parameters.

To obtain a retransmission in voltage, the user should install one shunt resistor (500 Ω max.) on the analogical output terminals. The value of this resistor depends on the voltage tension desired.

**LBD – LOOP BREAK DETECTION**

The parameter defines a time interval, in minutes, within which the PV is expect to react to a control output signal. If the PV does not react properly within the time interval configured in **Lbdt**, the controller interprets this as a control loop break and signals this occurrence in the display.

A **LBD** event may be sent to any output channel. Simply configure the **LBD** function to the desired output channel (OUT1 or OUT2): the selected output will be activated when a **LBD** condition is detected. When the **Lbdt** parameter is programmed with 0 (zero), the **LBD** function is disabled.

The **LBD** is useful in detecting system failures, such us defective sensors or actuators, loads and power supply, among others.

**SAFE OUTPUT VALUE WITH SENSOR FAILURE**

This function defines an output value (user defined) to be assigned to the control output in the event of a sensor failure.

When the input sensor is identified as broken, the controller switches the control mode to **MANUAL** while forcing **MV** to assume the user configured value in the **IEou** parameter. This function requires that one of the alarms be configured as **IErr** and the **IEou** parameter (control output percentage) programmed with a value other then 0 (zero).

Once this function is triggered, the controller remains in **SAFE** mode (**MANUAL** control output) even after the sensor failure appears to be fixed. The operator intervention is required for switching back to **AUTO** mode.

**IEou** values are only 0 and 100 % when in **ON/OFF** control mode. For **PID** control mode any value in the range from 0 to 100 % is accepted.

**OFFSET**

Allows fine adjustments to the **PV** reading for compensation of sensor error.

**SOFT START**

The soft-start feature avoids abrupt variations in the power delivered to the load regardless of the system power demand.

This is accomplished by defining a limiting ramp for the control output. The output is allowed to reach maximum value (100 %) only after the time programmed (in seconds) in the soft-start parameter has elapsed.

The Soft-start function is generally used in processes that require slow start-up, where the instantaneous application of 100 % of the available power to the load may cause damages to parts of the system.

In order to disable this function, the soft-start parameter must be configured with 0 (zero).

**Note:**

- 1- This feature is available only with **PID** (Proportional Band greater than zero).
- 2- This feature is disabled if the parameter is set to 0 (zero).

**PROGRAMS OF RAMP AND SOAK**

The controller allows the creation of **one** ramps and temperature soaks program. This program is created from the values definition of **SP** and time intervals, defining up to nine (9) **program segments**. The figure below shows a program model with 9 segments:

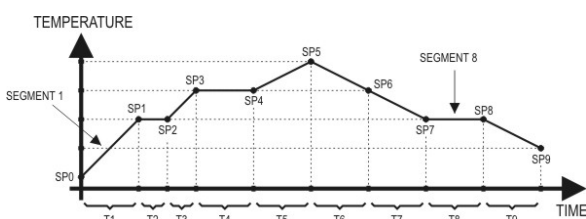

Fig. 04 - Example of ramps and soaks program

The program created is storage permanently on the controller's ram. It may be always changed, executed and repeated whenever necessary.

For the program's execution:

- 1- Turn off the outputs (**run= no**);
- 2- Enable the parameter execution **EPF= YES**;
- 3- Start-up the outputs: (**run= YES**).

Once the program execution is started, the controller starts to create automatically the **SP** values defined for each program segment. The **SP** adjustment on the indication screen is blocked.

**Program Toleration Function - Ptol**

The program toleration function "**Ptol**" defines the maximum error limit between **PV** and **SP** values during the program execution. If this limit is exceeded, the time counting of the segment (**Pt1...Pt9**) is stopped until the error is within the established tolerance. With a value >0 the user indicates in its program that priority must be given to PV in relation to the indeterminate value times.

If 0 is programmed in the tolerance (**Ptol= 0**), the controller executes the program defined without considering eventual errors between **PV** and **SP**. Thus, the user defines that the priority has to be given for the execution time of the program.

**Programs with few Segments**

For the execution of programs with few segments, it is enough to program 0 (zero) for the time interval of the segment, which succeeds the last segment of the desired program.

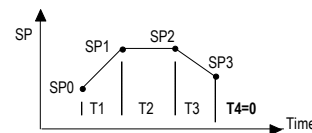

Fig. 05 - Program example with three segments

**Successive Repetitions of a Program**

The program created may be repeated for several times, always restarting immediately after the end of each execution.

The parameter **rPEP** (**rePeat Program**) in the Programs cycle configures the number of times the program must be **REPEATED**. It determines the number of executions besides the first execution.

With 0, the program is executed once. It won't repeat.

Important: After the last execution of the program, all controller outputs will be turned off and the **RUN** parameter is **OFF**.

**OPERATION**

The controller's front panel, with its parts, can be seen in the **Fig. 06**:

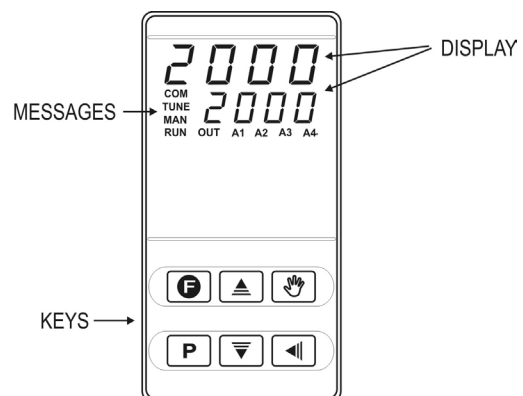

Fig. 06 - Identification of the parts referring to the front panel

**Display:** It shows the variable measured, configuration parameters symbols and its respective values/conditions.

**TUNE indicator:** Stays **ON** while the controller is in tuning process.

**OUT indicator:** It shows the instantaneous state of the controller output(s).

**A1 and A2 indicator:** signalize the occurrence of alarm situation.

**P key:** Key used to forward the successive parameters and parameters cycles.

▲ **Increment key** and ▼ **Decrement key:** allow altering the values / conditions of the parameters.

◀ **Back key:** allow altering the values of the parameters.

**START-UP**

Upon the energizing, the controller shows the number of its software version in the first 3 seconds. Then, it shows the process variable value (PV) measured (temperature) on the upper display. The SP value is showed on the lower display. This is the **Indication Screen**.

To operate in a process, the controller is required to be configured previously. The configuration consists of a definition of each one of the several parameters showed. The user must understand about the importance of each parameter and, for each one, determine one valid condition or a valid value.

The configuration parameters are together in affinity groups, known as parameters cycles. The 6 levels of parameters are:

Operation / Tuning / Program / Alarms / Input / Calibration

The **P** key is used for accessing the parameters within a level:

Keeping the **P** key pressed, at every 2 seconds the controller jumps to the next level of parameters, showing the first parameter of each level:

PV > **ALtun** > **PtoL** > **FuRI** > **TYPE** > **PASS** > PV ...

To enter a particular level, simply release the “P” key when the first parameter in that level is displayed. To walk through the parameters in a level, press the “P” key with short strokes. To go back to the previous parameter in a cycle, press ◀.

Each parameter is displayed with its prompt in the upper display and value/condition in the lower display. Depending on the level of parameter protection adopted, the parameter **PASS** precedes the first parameter in the level where the protection becomes active. See section **CONFIGURATION PROTECTION**.

**DESCRIPTION OF THE PARAMETERS**

**OPERATION CYCLE**

<b>PV + SP</b>	<b>PV indication.</b> The measured temperature value (PV) is shown on the upper display (red). Control Setpoint (SP) value is shown on the lower display (green).
<b>Ctrl</b>	<b>Control Mode:</b> <b>Auto</b> - in automatic mode. <b>MAN</b> - in manual mode.
<b>PV + MV</b>	<b>MV Value</b> - The upper display shows PV value and the lower display shows the <b>percentage</b> of MV applied to the control output.  In automatic control mode, the MV value is showed visually only. In manual control mode, the MV value may be changed by the user. To differ this screen from SP screen, the MV value blinks constantly.
<b>EP</b>	<b>Enable Program</b> Selects the ramp and soak profile program to be executed.  <b>no</b> - the program is not executed <b>YES</b> - the program is executed  With enabled outputs ( <b>run= YES</b> ), the program starts right after the program is selected.
<b>run</b>	<b>RUN Function.</b> Enables control outputs and alarms.  <b>YES</b> - Outputs enables. <b>no</b> - Outputs not enabled.

**TUNING CYCLE**

<b>ALtun</b>	<b>Auto-Tune:</b> Enables the auto-tuning function for the PID parameters ( <b>Pb</b> , <b>Ir</b> , <b>dL</b> ). Refer PID Parameters Determination chapter in this manual and on website <a href="http://www.novusautomation.com">www.novusautomation.com</a> for further details.  <b>OFF</b> - Turned off. (no PID tuning) <b>FAST</b> - Execute the tuning in fast mode. <b>FULL</b> - Execute the tuning in accurate mode.
<b>Pb</b>	<b>Proportional Band</b> - Value of the term P of the control mode PID, in percentage of the maximum span of the input type. Adjust of between 0 and 500.0 %. <b>When set to zero (0), control action is ON/OFF.</b>
<b>Ir</b>	<b>Integral Rate</b> - Value of the term I of the PID algorithm, in repetitions per minute (Reset). Adjustable between 0 and 99.99. Displayed only if proportional band ≠ 0.
<b>dL</b>	<b>Derivative Time</b> - Value of the term D of the control mode PID, in seconds. Adjustable between 0 and 300.0 seconds. Displayed only if proportional band ≠ 0.
<b>CL</b>	<b>Cycle Time</b> - Value in seconds in the PWM cycle period of PID control. Adjustable between 0.5 and 100.0 seconds. Displayed only if proportional band ≠ 0.
<b>HYSt</b>	<b>Control Hysteresis</b> - Is the hysteresis for ON/OFF control (set in temperature units). This parameter is only used when the controller is in ON/OFF mode ( <b>Pb=0</b> ).
<b>ACt</b>	<b>Action Control:</b> <b>rE</b> Control with <b>Reverse Action</b> . Appropriate for <b>heating</b> . Turns control output on when PV is below SP. <b>dIr</b> Control with <b>Direct Action</b> . Appropriate for <b>cooling</b> . Turns control output on when PV is above SP.
<b>SFSt</b>	<b>SoftStart Function</b> – Time interval, in seconds, in which the control limits the speed of increase of the control output (MV). From 0 to 9999 s. Zero value ( 0 ) disables the SoftStart function. Displayed only if proportional band ≠ 0.
<b>Out 1 Out 2 Out 3</b>	Assign functions to the output channels OUT1, OUT2 and OUT3:  <b>oFF</b> Not used. <b>Ctrl</b> Control output. <b>R1</b> Alarm 1 output. <b>R2</b> Alarm 2 output. <b>Lbd</b> Loop Break Detect Alarm.
<b>Out 4</b>	Operation mode of OUT4 output channel:  <b>oFF</b> Not used. <b>Ctrl</b> Digital control output (0 or 20 mA) <b>R1</b> Alarm output 1.(0 or 20 mA) <b>R2</b> Alarm output 2.(0 or 20 mA) <b>Lbd</b> Acts as the output for LB function <b>C.020</b> Analogical Control Output 0-20 mA <b>C.420</b> Analogical Control Output 4-20 mA <b>P.020</b> PV Retransmission 0-20 mA <b>P.420</b> PV Retransmission 4-20 mA <b>S.020</b> SP Retransmission 0-20 mA <b>S.420</b> PV Retransmission 4-20 mA

**PROGRAMS CYCLE**



<b>PtoL</b>	<b>Program Tolerance</b> - Maximum admitted deviation of PV with respect to SP. If exceeded, the program execution is suspended (the internal timer freezes) until the deviation be returns back within the defined tolerance. The value 0 (zero) disables the function.
<b>PSP0 PSP9</b>	<b>Program SP's, 0 to 9:</b> Group of 10 values of SP that define the Ramp and Soak profile segments.
<b>Pt1 Pt9</b>	<b>Program Time - Time intervals of program segments.</b> Defines the time of duration, in minutes, of each 9 program segments. Configurable between 0 and 9999 minutes.
<b>PE1 PE9</b>	<b>Program event - Program Segment Alarm.</b> Parameters that define which alarms are to be activated during the execution of a certain program segment:  <b>OFF</b> Do not start the alarm in this segment. <b>A1</b> Start alarm 1 when the program reaches this segment. <b>A2</b> Start alarm 2 when the program reaches this segment. <b>A1A2</b> Start alarm 1 and 2 when the program reaches this segment. The alarms chosen must have its function configured as "r5".
<b>rPLP</b>	<b>Repeat Program</b> - Determines the number of times which one program must be REPEATED besides the first execution. Configurable between 0 and 9999 times. After the last execution, all controller outputs are turned off ((RUN=OFF)).

**ALARMS CYCLE**

<b>FuA1 FuA2</b>	<b>Function Alarm.</b> Defines the functions for the alarms among the options of the <b>Table 02</b> .
<b>SPR1 SPR2</b>	<b>Alarm SP:</b> Value that defines the alarms actuation point. For alarms programmed with functions of <b>Differential</b> type, these parameters define deviations.
<b>bLA1 bLA2</b>	<b>Blocking Alarm.</b> <b>YES</b> Enables initial blocking. <b>no</b> Inhibits initial blocking.
<b>HYR1 HYR2</b>	<b>Alarm Hysteresis.</b> Defines the difference between the value of PV at which the alarm is triggered and the value at which it is turned off (in engineering units).
<b>FLSh</b>	<b>Flash.</b> Allows visual signalization of an alarm occurrence by flashing the indication of PV in the operation level. <b>YES</b> Enables the alarm signalization blinking PV. <b>no</b> Disable the alarm signalization blinking PV.

**INPUT CYCLE**

<b>TYPE</b>	<b>Input Type.</b> Selects the input signal type to be connected to the process variable input. Refer to <b>Table 01</b> .
<b>FLtr</b>	<b>Digital Input Filter.</b> Used to improve the stability of the measured signal (PV). Adjustable between 0 and 20. In 0 (zero) it means filter turned off and 20 means maximum filter. The higher the filter value, the slower is the response of the measured value.
<b>dPPo</b>	<b>Decimal Point.</b> Determines the presentation of the decimal point.

<b>unit</b>	<b>Unit.</b> Defines the temperature unit to be used: <b>C</b> Indication in Celsius. <b>F</b> Indication in Fahrenheit.
<b>OFFS</b>	<b>Offset.</b> Parameter that allows the user to correct the PV value indicated.
<b>SPLL</b>	<b>SP Low Limit.</b> Defines the SP lower limit. To 0-50 mV input type sets the lower range for SP and PV indication.
<b>SPHL</b>	<b>SP High Limit.</b> Defines the SP upper limit.
<b>IEou</b>	Percentage value to be applied to the output when a failure in the sensor connected to the controller input occurs.
<b>Lbdt</b>	Time interval for the LBD function. Defines the maximum interval of time for the PV to react to a control command. In minutes.
<b>FEn</b>	<b>F Enable.</b> Enables the utilization of F key to execute the RUN function. <b>YES</b> Enables F key to execute the RUN function. <b>no</b> Disables it.
<b>MEn</b>	<b>M Enable.</b> Enables the utilization of  key to change the control mode to Automatic or Manual. <b>YES</b>  key enabled. <b>no</b>  key disable.

**CALIBRATION CYCLE**

All types of input are calibrated in the factory. If a new calibration is required, it should be performed by a skilled professional. If this cycle is accessed accidentally, do not change its parameters.

<b>PASS</b>	<b>Password.</b> This parameter is presented before the protected cycles. See item Protection of Configuration.
<b>CALib</b>	<b>Calibration.</b> It enables the calibration possibility of the controller. When are disabled, the related parameters calibration are hidden.
<b>InLC</b>	<b>Input Low Calibration.</b> Enter the value corresponding to the low scale signal applied to the analog input.
<b>InHC</b>	<b>Input High Calibration.</b> Enter the value corresponding to the full scale signal applied to the analog input.
<b>OutLC</b>	<b>Output Low Calibration.</b> Analog output calibration. Introduction of lower value present in the analog output.
<b>OutHC</b>	<b>Output High Calibration.</b> Analogic output calibration. Introduction of higher value present in the analog output.
<b>rStr</b>	<b>Restore.</b> Restores the factory calibration for all inputs and outputs, disregarding modifications carried out by the user.
<b>CJ</b>	<b>Cold Junction.</b> Temperature of controller cold junction.
<b>PASC</b>	<b>Password Change.</b> Allows defining a new access password, always different from zero.
<b>Prot</b>	<b>Protection.</b> Sets up the Level of Protection. See <b>Table 03</b> .

## CONFIGURATION PROTECTION

The controller provides means for protecting the parameters configurations, not allowing modifications to the parameters values, avoiding tampering or improper manipulation. The parameter **Protection (Pract)**, in the Calibration level, determines the protection strategy, limiting the access to particular levels, as shown by the below.

Protection Level	Protection Levels
1	Only the Calibration level is protected.
2	Calibration and Input levels are protected.
3	Alarms, Input and Calibration levels are protected.
4	Program, Alarms, Input and Calibration levels are protected.
5	Tuning, Program, Alarms, Input and Calibration levels are protected.
6	All levels are protected, but the <b>SP</b> screen in the Operation level.
7	All levels are protected, including SP.

Table 03 – Levels of Protection for the Configuration

### ACCESS PASSWORD

The protected levels, when accessed, request the user to provide the **Access Password** for granting permission to change the configuration of the parameters on these levels. The prompt **PASS** precedes the parameters on the protected levels. If no password is entered, the parameters of the protected levels can only be visualized.

The Access Password is defined by the user in the parameter Password Change (**PASC**), present in the Calibration Level. **The factory default for the password code is 1111.**

### PROTECTION ACCESS PASSWORD

The controller foresees a safety system which helps to avoid the input of many passwords, trying to insert the correct one. Once 5 consecutive invalid passwords are inserted, the controller stops to accept passwords for 10 minutes.

### MASTER PASSWORD

The Master Password is intended for allowing the user to define a new password in the event of it being forgotten. The Master Password doesn't grant access to all parameters, only to the Password Change parameter (**PASC**). After defining the new password, the protected parameters may be accessed (and modified) using this new password.

The master password is made up by the last three digits of the serial number of the controller **added** to the number 9000.

As an example, for the equipment with serial number 07154321, the master password is 9 3 2 1.

Controller serial number is displayed by pressing  for 5 seconds.

## DETERMINATION OF PID PARAMETERS

Automatic tuning allows the controller to obtain P.I.D parameters (proportional band, full rate, derivative time).

During the process of determining automatically the PID parameters, the system is controlled in ON/OFF in the programmed Setpoint. The auto-tuning process may take several minutes to be completed, depending on the system. The steps for executing the PID auto-tuning are:

- Turn-off the outputs (RUN= NO).
- Adjust the SP value desired for the process.
- Enable auto-tuning at the parameter (ATUN= FAST or FULL)
- Turn-on the outputs (RUN= YES).

The option **FAST** performs the tuning in the minimum possible time, while the option **FULL** gives priority to accuracy over the speed.

The sign TUNE remains lit during the whole tuning phase. The user must wait for the tuning to be completed before using the controller.

During the automatic tuning execution, PV oscillations may be induced in the process around the setpoint.

If the tuning does not result in a satisfactory control, refer to **Table 04** for guidelines on how to correct the behavior of the process.

PARAMETER	VERIFIED PROBLEM	SOLUTION
Proportional Band	Slow answer	Decrease
	Great oscillation	Increase
Rate Integration	Slow answer	Increase
	Great oscillation	Decrease
Derivative Time	Slow answer or instability	Decrease
	Great oscillation	Increase

Table 04 - Guidance for manual adjustment of the PID parameters

For further details on PID tuning, visit our web site: [www.novusautomation.com](http://www.novusautomation.com).

## MAINTENANCE

### PROBLEMS WITH THE CONTROLLER

Connection errors and inadequate programming are the most common errors found during the controller operation. A final revision may avoid loss of time and damages.

The controller displays some messages to help the user identify problems.

MESSAGE	DESCRIPTION OF THE PROBLEM
----	Open input. No sensor or signal.
<b>Err 1</b> <b>Err 6</b>	Connection and/or configuration problems. Check the wiring and the configuration.

Other errors messages showed by the controller represent internal damages which implies necessarily in the submission of the equipment for maintenance.

### CALIBRATION OF THE INPUT

Visit our web site for further information [www.novusautomation.com](http://www.novusautomation.com).

## IDENTIFICATION

<b>N2020 - PRR</b>	Basic version. Three outputs. OUT1= pulse / OUT2= relay / OUT3= relay
<b>N2020 - PRRA</b>	For outputs. OUT1= pulse / OUT2= relay / OUT3= relay OUT4= Analogic output 0-20 / 4-20 mA

## SPECIFICATIONS

**DIMENSIONS:**.....48 x 96 x 92 mm (1/8 DIN)

Approximate:..... 180 g

**POWER SUPPLY:**.....100 to 240 Vac ( $\pm 10\%$ ), 50/60 Hz

.....48 to 240 Vdc ( $\pm 10\%$ )

Maximum consumption:..... 6 VA

### ENVIRONMENTAL CONDITIONS:

Operation Temperature: ..... 0 to 50 °C

Relative Humidity:.....80 % @ 30 °C

For temperatures above 30 °C, reduce 3 % for each °C

Internal use; Category of installation II, Degree pollution 2;  
altitude < 2000 meters

**INPUT** ..... Thermocouples **J; K; T** and **Pt100** (according **Table 01**)

Internal Resolution:.....32767 levels (15 bits)

Resolution of Display:..... 12000 levels (de -1999 up to 9999)

Rate of input reading: .....up 20 per second

Accuracy: ..(\*) Thermocouples **J, K, T**: 0.25 % of the span  $\pm 1$  °C

.....Pt100: 0.2 % of the span

Input Impedance:.....Pt100 and thermocouples: > 10 M $\Omega$

Measurement of Pt100: ..... 3-wire type, ( $\alpha=0.00385$ )

With compensation for cable length, excitation current of  
0.170 mA.

**OUT1:** .....Voltage pulse, 5 V / 25 mA

**OUT2:** .....Relay SPST; 1.5 A (Resistive) / 240 Vac / 30 Vdc

**OUT3:** .....Relay SPST; 1.5 A (Resistive) / 240 Vac / 30 Vdc

**OUT4:** ..... 0-20 / 4-20 mA / 500  $\Omega$  max. / 12.000 levels

**FRONT PANEL:** ..... IP65, Polycarbonate (PC) UL94 V-2

**ENCLOSURE:** ..... IP30, ABS+PC UL94 V-0

**ELECTROMAGNETIC COMPATIBILITY:** ..... EN 61326-1:1997  
and EN 61326-1/A1:1998

**SAFETY:** ..... EN61010-1:1993 and EN61010-1/A2:1995

**SPECIFIC CONNECTIONS FOR TYPE FORK TERMINALS 6.3 MM;**

**PROGRAMABLE CICLO OF PWM OF 0.5 UP 100 SECONDS;**

**STARTS UP OPERATION AFTER 3 SECONDS CONNECTED TO  
THE POWER SUPPLY.**

(\*) When a thermocouple is used as a temperature sensor, 15-minutes  
minimum time for terminal accommodations shall be observed.

## SAFETY INFORMATION

Any control system design should take into account that any part of the system has the potential to fail. This product is not a protection or safety device and its alarms are not intended to protect against product failures. Independent safety devices should be always provided if personnel or property are at risk.

Product performance and specifications may be affected by its environment and installation. It's user's responsibility to assure proper grounding, shielding, cable routing and electrical noise filtering, in accordance with local regulations, EMC standards and good installation practices.

## SUPPORT AND MAINTENANCE

This product contains no serviceable parts inside. Contact our local distributor in case you need authorized service. For troubleshooting, visit our FAQ at [www.novusautomation.com](http://www.novusautomation.com).

## LIMITED WARRANTY AND LIMITATION OF LIABILITY

NOVUS warrants to the original purchaser that this product is free from defects in material and workmanship under normal use and service within one (1) year from the date of shipment from factory or from its official sales channel to the original purchaser.

NOVUS liability under this warranty shall not in any case exceed the cost of correcting defects in the product or of supplying replacement product as herein provided and upon the expiration of the warranty period all such liability shall terminate.

For complete information on warranty and liability limitations, check appropriate section in our web site: [www.novusautomation.com](http://www.novusautomation.com).