



Controller N3000

UNIVERSAL PROCESS CONTROLLER – INSTRUCTIONS MANUAL – V3.0x C

SAFETY ALERTS

The symbols below are used on the equipment and throughout this document to draw the user's attention to important operational and safety information.

CAUTION or WARNING: Read complete instructions prior to installation and operation of the unit.	CAUTION or WARNING: Electrical Shock Hazard

All safety related instructions that appear in the manual must be observed to ensure personal safety and to prevent damage to either the instrument or the system. If the instrument is used in a manner not specified by the manufacturer, the protection provided by the equipment may be impaired.

PRESENTATION

A controller of universal characteristics, it accepts most of the sensors and signals used in industry in a single model and it provides all types of output needed for the most diverse processes.

The configuration can be performed directly on the controller or through the USB interface. The **NConfig** software (free) is the configuration management tool. Connected to the USB of a *Windows* computer, the controller is recognized as a serial communications port (COM) running with a Modbus RTU protocol.

Through the USB interface, even if disconnected from the power supply, the configuration performed in a piece of equipment can be saved in a file and repeated in other pieces of equipment that require the same configuration.

It is important that the users read carefully this manual before using the controller. Verify if the release of this manual matches the instrument version (the firmware version is shown when the controller is energized).

- Multi-sensor universal input (sensors and standard signals);
- Relay, 4-20 mA and logic pulse control outputs all available in the standard model;
- Self-tuning of PID parameters;
- Automatic / Manual function with "bumpless" transfer;
- Four modes of independent alarms, with functions of minimum, maximum, differential (deviation), open sensor and event;
- Timer functions that can be associated to the alarms;
- Retransmission of PV or SP in 0-20 mA or 4-20 mA;
- Input for remote setpoint;
- Digital input with 5 functions;
- Programmable *soft-start*;
- 7 setpoint profile programs with 7 segments each, with the ability to be linked together for a total of 49 segments;
- RS-485 Serial communication, MODBUS RTU protocol;
- Password for parameters protection;
- Universal power supply.

CONFIGURATION

INPUT TYPE SELECTION

Select the input type (in parameter "**TYPE**") from **Table 1** below.

TYPE	CODE	CHARACTERISTICS
J	tc J	Range: -110 to 950 °C (-166 to 1742 °F)
K	tc K	Range: -150 to 1370 °C (-238 to 2498 °F)
T	tc t	Range: -160 to 400 °C (-256 to 752 °F)
N	tc n	Range: -270 to 1300 °C (-454 to 2372 °F)
R	tc r	Range: -50 to 1760 °C (-58 to 3200 °F)
S	tc S	Range: -50 to 1760 °C (-58 to 3200 °F)
B	tc b	Range: 400 to 1800 °C (752 to 3272 °F)
E	tc E	Range: -90 to 730 °C (-130 to 1346 °F)
Pt100	Pt	Range: -200 to 850 °C (-328 to 1562 °F)
0-50 mV	L050	Linear Signals Programmable indication from-1999 to 9999
4-20 mA	L420	
0-5 Vdc	L05	
0-10 Vdc	L0.10	
4-20 mA	59r-t	4-20 mA input with Square Root extraction. Programmable indication from-1999 to 9999
4-20 mA NON- LINEAR	Ln J	Non-linear Analog Signals Indication range depends on the selected sensor
	Ln K	
	Ln t	
	Ln n	
	Ln r	
	Ln S	
	Ln b	
	Ln E	
	LnPt	

Table 1 - Input types

Note: All input types are factory calibrated.

OUTPUTS, ALARMS AND DIGITAL INPUTS CONFIGURATION

The controller input/output channels can assume multiple functions, depending on configuration: control output, alarm output, digital output, digital input, and PV or SV analog retransmission. These channels are identified as I/O1, I/O2, I/O3, I/O4, I/O 5 and I/O6.

The basic controller model comes loaded with:

- I/O1 and I/O2 - SPDT relay output;
- I/O3 and I/O4 - SPST relay output;
- I/O5 - analog output (0-20 or 4-20 mA), pulse 10 V max, digital I/O;
- I/O6 - Digital Input.

Note: When a function is selected to operate through digital input, the controller does not respond to the equivalent function command given in the frontal keypad.

The function to be used in each channel of I/O is defined by the user in accordance with the options shown in the **Table 2**.

I/O FUNCTION	I/O TYPE	CODE
No function	-	oFF
Alarm 1 Output	Output	R1
Alarm 2 Output	Output	R2
Alarm 3 Output	Output	R3
Alarm 4 Output	Output	R4
LDB Output - Loop break detection	Output	Lbd
Control Output (Relay or Digital Pulse)	Output	ctrL
Automatic/Man mode change	Digital Input	MAN
Run/Stop mode change	Digital Input	run
Selected Remote SP	Digital Input	rSP
Freezes program execution	Digital Input	HPRG
Program 1 selection	Digital Input	Pr 1
0 to 20 mA analog control output	Analog Output	C.020
4 to 20 mA analog control output	Analog Output	C.420
0 to 20 mA PV retransmission	Analog Output	P.020
4 to 20 mA PV retransmission	Analog Output	P.420
0 to 20 mA SP retransmission	Analog Output	S.020
4 to 20 mA SP retransmission	Analog Output	S.420

Table 2 - I/O channel functions

The description for the functions follows:

- **oFF** - No function.

The I/O channel programmed with code 0 will not be used by the controller. It is available to be used by serial communication as digital output.

- **R1, R2, R3, R4** - Alarm output.

Available for all I/O channels. The selected channel can be used as output to Alarms 1 to 4.

- **Lbd** – Loop Break Detector function.

Assigns the output of the Loop Break Detector alarm to an I/O channel. Available to all I/O channels.

- **ctrL** - PWM control output.

Defines the channel to be used as control output (relay or digital pulse). Available for all the channels. The digital pulse is available on (when available) I/O5 and I/O6.

- **MAN** - Digital input with Auto/Manual function.

Defines the channel as Digital Input with the function of switching the control mode between **Automatic** and **Manual**. Available for I/O5, I/O6 and key **MAN**.

Closed: Manual control /no

Opened: Automatic control /YES

- **run** - Digital input - Standard for I/O5, I/O6 and **MAN** key. Start/Stop input ("**run**": YES / no).

Closed: outputs enabled/ YES

Opened: outputs disabled/ no

- **rSP** - Digital input - Standard for I/O5, I/O6 and **MAN** key.

Closed: remote SP (4-20 mA in remote SP input)

Opened: main SP (internal programmed SV)

- **HPRG** - Digital input - Standard for I/O5, I/O6 and **MAN** key.

Opened: enables R&S program

Closed: holds R&S program (the program resumes when the contact is opened again)

Closed Contact: Enables execution of the program

Opened Contact: Interrupts execution of the program

Note: Even when the execution of the program is interrupted, the control output remains active and controlling the process at the point (Setpoint) of interruption. The program will resume its normal execution starting from this same point when the digital input is closed.

- **Pr 1** - Digital input - Standard for I/O5, I/O6 and **MAN** key. Selects R&S program 1. Used to alternate between the main Setpoint and a second Setpoint defined by the R&S program 1.

Closed: selects program 1

Opened: uses main Setpoint

- **C.020 / C.420** - 0-20 mA and 4-20 mA Control Output.

Available for I/O 5 only, defines the channel as a 0-20 mA and 4-20 mA control output.

- **P.020 / P.420** - 0-20 mA and 4-20 mA PV retransmissions.

Available for I/O 5 only, configures the channel to retransmit the PV measurement in 0-20 mA and 4-20 mA.

- **S.020 / S.420** - 0-20 mA and 4-20 mA SP (Setpoint) retransmissions.

Available for I/O 5 only, configures the channel to retransmit the values of SP in 0-20 mA and 4-20 mA.

ALARMS FUNCTIONS

The controller has 4 independent alarms. They can be programmed to operate with eight different functions, represented in **Table 3**.

- **oFF** – Alarms turned **oFF**.

- **IErr** – Sensor break alarm

It is activated whenever the input sensor is broken or disconnected.

- **rS** – Ramp & soak program event alarm

This alarm is activated by the Ramp & Soak program (refer to the PROGRAMS OF RAMP AND SOAK section on how to set the event alarm).

- **Lo** – Alarm of Absolute Minimum Value

It is activated when the measured value is **below** the value defined in the alarm Setpoint.

- **HI** – Alarm of Absolute Maximum Value

It is activated when the measured value is **above** the value defined in the alarm Setpoint.

- **dIF** – Alarm of Differential Value

In this function, the parameters "**SPA1**", "**SPA2**", "**SPA3**" and "**SPA4**" represent the PV deviation as compared to the main SP.

Using the Alarm 1 as example: for Positive SPA1 values, the differential alarm will be triggered when the PV value is **out** of the range defined in:

$$(SP - SPA1) \text{ to } (SP + SPA1)$$

For a negative SPA1 value, the differential alarm will be triggered when the PV value is **within** the range defined above

- **dIFL** – Alarm of Minimum Differential Value

It is activated when the PV value is below the value defined in:

$$(SP - SPA1)$$

Using the Alarm 1 as example.

- **dIFH** – Alarm of Maximum Differential Value

It is activated when the PV value is above the value defined in:

$$(SP + SPA1)$$

Using the Alarm 1 as example.

The alarm functions are described in **Table 3**.

TYPE	PROMPT	ACTION
Disabled	oFF	No active alarm. This output can be used as a digital output to be set by the serial communication.
Sensor Break (input Error)	IErr	Alarm will be ON if PV sensor breaks, input signal is out of range or Pt100 is shorted.
Event Alarm (ramp and Soak)	rS	Can be activated at a specific segment of ramp and soak program.
Low Alarm	Lo	
High Alarm	HI	
LOW Differential	dIFL	
HIGH Differential	dIFH	
Differential	dIF	

Table 3 - Alarm functions

ALARM TIMER FUNCTIONS

The controller alarms can be configured to perform 4 timer modes:

- Continuous (normal mode).
- One pulse with defined duration;
- Delayed activation;

The illustrations in **Table 4** show the behavior of the alarm output for various combinations of times T1 and T2. The timer functions can be configured in parameters **AIt1, A2t1, A3t1, A4t1, AIt2, A2t2, A3t2, A4t2**.

ALARM FUNCTION	T1	T2	ACTION
Normal	0	0	
Delayed	0	1 s to 6500 s	
Pulse	1 s to 6500 s	0	
Oscillator	1 s to 6500 s	1 s to 6500 s	

Table 4 - Advanced Timer Alarm

The LEDs associated to the alarms will light when the alarm condition is recognized, not following the actual state of the output, which may be temporarily OFF because of the temporization.

ALARM INITIAL BLOCKING

The initial blocking option inhibits the alarm from being recognized if an alarm condition is present when the controller is first energized. The alarm will actuate only after the occurrence of a non alarm condition followed by a new occurrence for the alarm.

The initial blocking is disabled for the sensor break alarm function.

SQUARE ROOT EXTRACTION

Available when input type **19** is selected. The indicator displays the square root of the current signal input applied to terminals 22 and 24.

ANALOG RETRANSMISSION OF PV AND SP

The analog output, when not used for control purposes, is available for retransmitting the SV and SP values in 0-20 or 4-20 mA. This analog output is electrically isolated from other inputs and outputs. The analog output signal is scalable, with the output range determined by the values programmed in the parameters **"SPLL"** and **"SPHL"**. To obtain a voltage output, connect a resistor shunt to the current output terminals.

It is possible to obtain a voltage output by installing a resistor shunt (550 Ω max.) to the current output terminals (terminals 7 and 8). The actual resistor value depends on the desired output voltage span.

SOFT START

The soft-start feature avoids abrupt variations in the power delivered to the load regardless of the system power demand.

This is accomplished by defining a limiting ramp for the control output. The output is allowed to reach maximum value (100 %) only after the time programmed in the soft-start parameter has elapsed.

The Soft-start function is generally used in processes that require slow start-up, where the instantaneous application of 100 % of the available power to the load may cause damages to parts of the system.

In order to disable this function, the soft-start parameter must be configured with 0 (zero).

Note:

- 1- This feature is available only with PID (Proportional Band greater than zero).
- 2- This feature is disabled if the parameter is set to 0 (zero)

REMOTE SETPOINT

The controller can have its Setpoint value defined by an analog, remotely generated signal. This feature is enabled through the channels I/O3, I/O4 or I/O5 when configured as digital inputs and configured with the function **rSP** (Remote SP selection) or through the parameter **ErSP**. The remote Setpoint input accepts the signals 0-20 mA, 4-20 mA, 0-5 V and 0-10 V.

For the signals of 0-20 and 4-20 mA, a shunt resistor of **100 Ω** is required between terminals, as shown in **Figure 4d**.

LBD - LOOP BREAK DETECTION ALARM

The parameter defines a time interval, in minutes, within which the PV is expect to react to a control output signal. If the PV does not react properly within the time interval configured in **Lbd.t**, the controller interprets this as a control loop break and signals this occurrence in the display.

A LBD event may be sent to any I/O channel. Simply configure the **Ldb** function to the desired I/O channel: the selected output will be activated when a **Ldb** condition is detected. When the **Lbd.t** parameter is programmed with 0 (zero), the **Ldb** function is disabled.

The **Ldb** is useful in system supervision and troubleshooting, allowing early detection of problems in the actuator, power source or load.

KEY FUNCTIONS

Both the **Ⓜ** key digital input can be programmed to execute functions **run**, **rSP**, **HPrG**, **PrI** shown in **Table 2**. The key function is configured in parameter (**FFun**).

EXTRA 24 VDC POWER SUPPLY – AUXILIAR P.S.

The controller provides a voltage power supply of 24 Vdc to excite field transmitters with 25 mA current capacity. Available at the back panel terminals 17 and 18.



USB INTERFACE

The USB interface is used for CONFIGURING or MONITORING the controller. The **NConfig** software must be used for the configuration. It makes it possible to create, view, save and open configurations from the equipment or files in your computer. The tool for saving and opening configurations in files makes it possible to transfer configurations between pieces of equipment and to make backup copies. For specific models, the **NConfig** software also makes it possible to update the firmware (internal software) of the controller through the USB.

For MONITORING purposes you can use any supervisory software (SCADA) or laboratory software that supports the MODBUS RTU communication on a serial communications port. When connected to the USB of a computer, the controller is recognized as a conventional serial port (COM x). Use the **NConfig** software or consult the DEVICE MANAGER in the Windows CONTROL PANEL to identify the COM port that was assigned to the controller. Consult the mapping of the MODBUS memory in the controller's communications manual and the documentation of your supervisory software to conduct the MONITORING process.

Follow the procedure below to use the USB communication of the equipment:

1. Download the **NConfig** software from our website and install it on your computer. The USB drivers necessary for operating the communication will be installed together with the software.
2. Connect the USB cable between the equipment and the computer. The controller does not have to be connected to a power supply. The USB will provide enough power to operate the communication (other equipment functions cannot operate).
3. Open the **NConfig** software, configure the communication and start recognition of the device.

 	<p>The USB interface IS NOT SEPARATE from the signal input (PV) or the controller's digital inputs and outputs. It is intended for temporary use during CONFIGURATION and MONITORING periods. For the safety of people and equipment, it must only be used when the piece of equipment is completely disconnected from the input/output signals. Using the USB in any other type of connection is possible but requires a careful analysis by the person responsible for installing it. When MONITORING for long periods of time and with connected inputs and outputs, we recommend using the RS485 interface, which is available or optional in most of our products.</p>
----------------------------------------------------------------------------------------------------------------------------------------------------------------------------	-----------------------------------------------------------------------------------------------------------------------------------------------------------------------------------------------------------------------------------------------------------------------------------------------------------------------------------------------------------------------------------------------------------------------------------------------------------------------------------------------------------------------------------------------------------------------------------------------------------------------------------------------------------------------------

INSTALLATION/ CONNECTIONS

The controller must be fastened on a panel, following the sequence of steps described below:

- Prepare a panel cut-out of 93 x 93 mm;
- Remove the mounting clamps from the controller;
- Insert the controller into the panel cut-out;
- Slide the mounting clamp from the rear to a firm grip at the panel.

The controller's internal circuits can be removed without undoing the connections on the back panel.

The controller complete set of features is drawn in **Fig. 1**. The features loaded in a particular unit are shown on its label

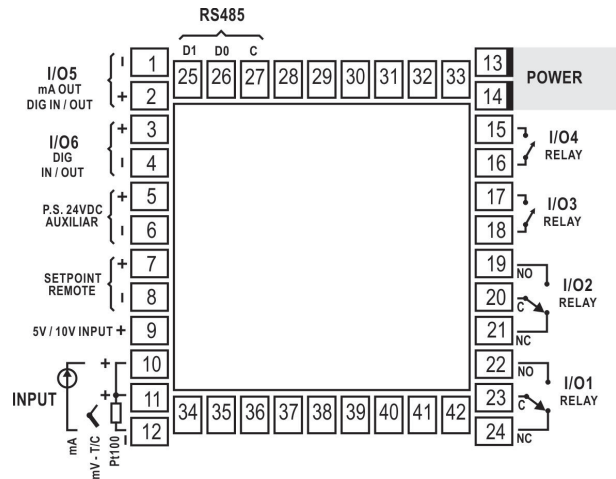

Fig. 1 – Back panel terminals

RECOMMENDATIONS FOR INSTALLATION

- Input signal wires should be laid out away from power lines and preferably inside grounded conduits.
- Instrument mains (line) supply should be suitable for this purpose and should not be shared.
- In controlling and monitoring applications, possible consequences of any system failure must be considered in advance. The internal alarm relay does not warrant total protection.
- Use of RC filters (47 R and 100 nF, serial) are highly recommended when driving solenoids, contactor coils or other inductive loads.

ELECTRICAL CONNECTIONS

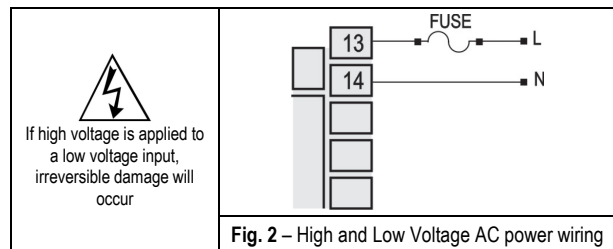
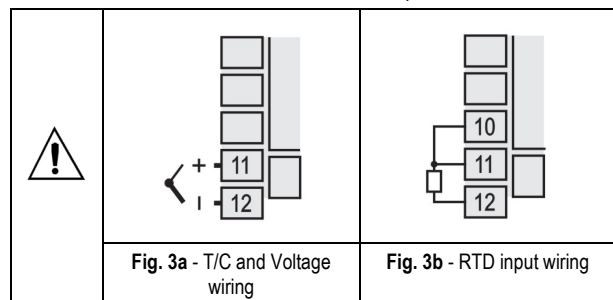

Fig. 2 – High and Low Voltage AC power wiring

INPUT CONNECTIONS

It is important that they are very well connected; the sensor wires must be well fixed in the terminals of the rear panel.



- Thermocouple (T/C) and 0-50 mV
The **Figure 3a** indicates the wiring for the thermocouple and 0-50 mV signals. If the thermocouple wires need to be extended, use appropriate compensation cables.

- RTD (Pt100):
Figure 3b shows the Pt100 wiring, for 3 conductors. For proper cable length compensation, use conductors of same gauge and length). For 4-wires Pt100, leave one conductor disconnected at the controller. For 2-wire Pt100, short-circuit terminals 22 and 23.

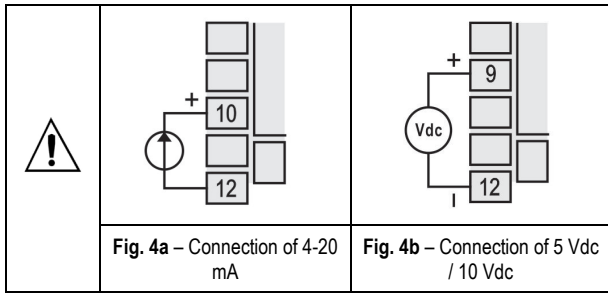

- 4-20 mA

Refer to Fig. 4a. (The controller provides an internal electronic shunt for the input current. No changes in the circuit are necessary).

- 0-5 Vdc / 0-10 Vdc:

Refer to Fig. 4b for connecting voltage signals.

- 4-20 mA:

The connections for current signals 4-20 mA must be carried-out according to Fig. 4c.

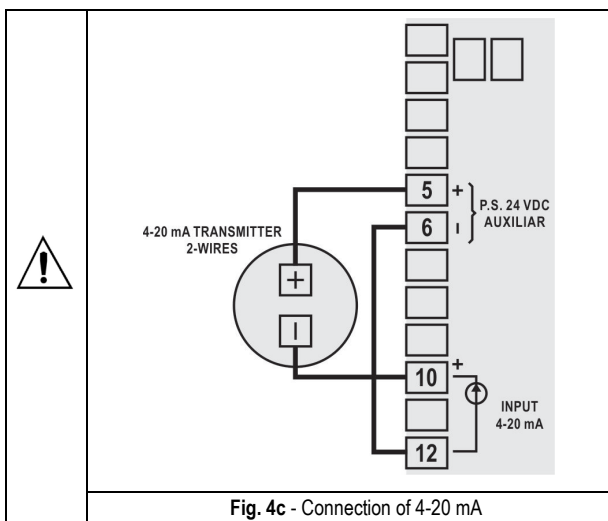

- Remote setpoint

The remote Setpoint (SP) is enabled by an external digital signal in either I/O5 or I/O6, when programmed with the code **rSP** (Select remote SP input).

An external resistor shunt of 100 Ω is required between the terminals 19 and 20.

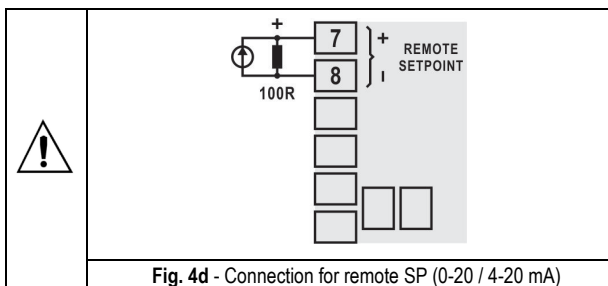

DIGITAL OUTPUT

I/O5 can also be configured as digital output. An example of usage is shown in Fig. 5. I/O5 is electrically isolated from the sensor input.

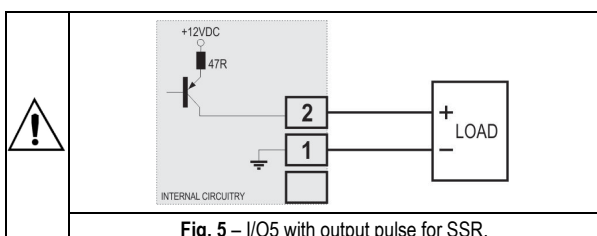

DIGITAL INPUT

I/O5 and I/O6 can be used as digital inputs, accepting either dry contact or NPN open collector signals. Fig. 6 shows a switch driving the I/O5 digital input. The digital input at I/O6 is driven only by dry contact signals. Fig. 7 shows a typical digital input wiring for I/O6.

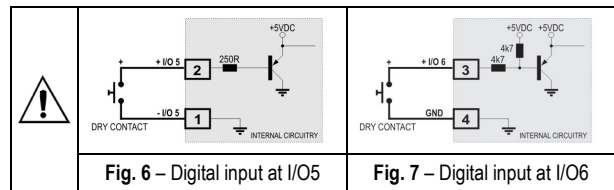

OPERATION

The front panel is shown in Fig. 8.

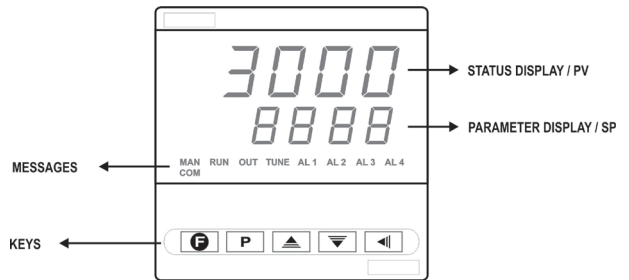

Status display/PV: shows the value of PV (Process Variable). When in programming mode, shows the parameter name.

Parameter display/SV: shows the SV (Setpoint Variable) value and the value of other parameters of the controller.

COM Indicator: Flashes when communication messages are sent by the controller.

TUNE Indicator: Lights during the execution of PID automatic tuning.

MAN Indicator: Lights when the controller is in manual.

RUN Indicator: Lights when the controller is active, with control and alarm outputs enabled.

OUT Indicator: For relay or pulse control output, reflects the actual state of the output. If an analog output is assigned for control, lights continuously.

A1, A2, A3 and A4 Indicators: Status of the alarms.

P - **PROG key:** used to walk through the menu cycles

⏪ - **BACK key:** go back to the previous displayed parameter

▲ - **INCREASE** and **▼** - **DECREASE keys:** Used to change parameter values

Ⓜ - **PROGRAMMABLE FUNCTION KEY:** Can be assigned to the special functions described for the **run**, **rSP**, **HPrE**, **e Pr I** according to Table 2.

When the controller is turned on, its firmware version is displayed for 3 seconds, after which the controller starts normal operation. The values of PV and SV are displayed and the outputs are enabled.

Before the controller is ready to be used in a given process, it requires some basic configuration, such as:

- Input type (T/C, Pt100, 4-20 mA).
- Control Setpoint Value (SP).
- Control Output Type (relays, 0-20 mA, 4-20 mA).
- PID parameters (or hysteresis for ON / OFF control)

Other functions, including alarms, ramp and soak, timer, digital input, etc., may be useful for a better system performance. The parameters are grouped in 7 cycles.

CYCLE	ACCESS
1- Operation	Free access parameters
2- Tuning	Reserved access parameters
3- R&S Program	
4- Alarms	
5- Input Configuration	
6- I/Os	
7- Calibration	

The parameters in the operation cycle (1st cycle) are easily accessed through the **[P]** key. The access deeper cycles use the combination of Keys:

[◀] (BACK) and [P] (PROG) pressed simultaneously

Press **[P]** to advance or **[◀]** to retrocede parameters within a cycle. At the end of each cycle, the controller returns to the operation cycle. Keep pressing the **[P]** key to move fast forward in the cycle.

Alternatively, the controller returns to the operation cycle after pressing the **[◀]** key for 3 seconds.

All configuration parameters are stored in protected memory. The values are saved when the keys **[P]** or **[◀]** are pressed after changing a parameter value. The value of SP is saved upon pressing the **[P]** key or every 25 seconds.

PROTECTION OF CONFIGURATION

The controller provides means for protecting the parameters configurations, not allowing modifications to the parameters values, avoiding tampering or improper manipulation.

The parameter **Protection (Pr_{act})**, in the Calibration cycle, determines the protection strategy, limiting the access to particular cycles, as shown by the table below.

Protection level	Protected cycles
1	Only the Calibration cycle is protected.
2	I/Os and Calibration cycles.
3	Tuning, I/Os and Calibration cycles.
4	Alarm, Tuning, I/Os and Calibration cycles.
5	Programs, Alarm, Tuning, I/Os and Calibration cycles.
6	Tuning, Programs, Alarm, Input, I/Os and Calibration cycles.
7	Operation (except SP), Tuning, Programs, Alarm, input, I/Os and Calibration cycles.
8	Operation, Tuning, Programs, Alarm, Input, I/Os and Calibration cycles.

Table 5 – Levels of Protection for the Configuration

Access Password:

The protected cycles, when accessed, request the user to provide the **Access Password** for granting permission to change the configuration of the parameters on these cycles.

The prompt **PRSS** precedes the parameters on the protected cycles. If no password is entered, the parameters of the protected cycles can only be visualized.

The Access Code is defined by the user in the parameter **Password Change (PRSC)**, present in the Calibration cycle. The factory default for the password code is 1111.

Protection of the access code

The protection system built into the controller blocks for 10 minutes the access to protected parameters after 5 consecutive frustrated attempts of guessing the correct password.

Master Password

The Master Password is intended for allowing the user to define a new password in the event of it being forgotten. The Master Password doesn't grant access to all parameters, only to the Password Change parameter (**PRSC**). After defining the new password, the protected parameters may be accessed (and modified) using this new password.

The master password is made up by the last three digits of the serial number of the controller **added** to the number 9000.

As an example, for the equipment with serial number 07154321, the master password is 9 3 2 1.

CONFIGURATION PARAMETERS

OPERATION CYCLE

<div style="border: 1px solid black; padding: 2px; margin-bottom: 5px;"> PV Indication (Red) </div> <div style="border: 1px solid black; padding: 2px;"> SV Indication (Green) </div>	PV / SP indication- The upper display shows the current value of PV. The lower display shows the control SP value.
Auto Control	Control Mode: YES -Means automatic control mode. no -Means manual control mode. Bumpless transfer between automatic and manual.
<div style="border: 1px solid black; padding: 2px; margin-bottom: 5px;"> PV Indication (Red) </div> <div style="border: 1px solid black; padding: 2px;"> MV Indication (Green) </div>	Screen PV and MV: The upper display shows PV value and the lower display shows the percentage of MV applied to the control output. When in manual control the MV value can be manually changed. When in auto mode the MV value can only be viewed. To distinguish the MV display from the SV display, the MV is shown flashing intermittently.
Pr_n Program number	Execution of Program - Selects the ramp and soak profile program to be executed. 0 -does not execute program 1 to 7 -number of the program to be executed
P.SEG	Indicative screen. Shows the current segments number of the running program.
t.SEG	Indicative screen. Shows the current segments remaining time.
run	Control Enable: YES -means that the control output and alarms are enabled. NO -means they are disabled.

AUTO TUNING CYCLE

Auto	Auto Tune: Enables the auto tuning feature for the PID parameters. YES -Auto-tune enable no -Do not execute auto tune
Pb	Proportional Band - Percentage of maximum input span. Select zero for ON / OFF control.
Ir Integral Rate	Value of the term I of the PID algorithm, in repetitions per minute. Displayed only if proportional band ≠ 0.
dt Derivative Time	Derivative Time - Value of the term D of the control mode PID, in seconds. Displayed only if proportional band ≠ 0.
t Cycle Time	Pulse Width Modulation (PWM) period in seconds. Displayed only if proportional band ≠ 0.

HYS <i>Hysteresis</i>	Control Hysteresis: This parameter is only shown for ON / OFF control. Displayed only if proportional band = 0.
Act <i>Action</i>	Control Action: rE -Reverse Action usually used for heating. dIr -Direct Action usually used for cooling.
bIAS	Bias function - Allows adding a percentage value between -100 % and +100 %. to the MV control output. The value 0 (zero) disables the function.
oULL <i>Output Low Limit</i>	Minimum percentage value for MV (Manipulated Variable) when in automatic control and PID. Default value: 0.0 %
oUHL <i>Output High Limit</i>	Maximum percentage value for MV when in automatic control and PID. Default value: 100.0%
Lbd	Time interval for the LBD function. In minutes.
SFS <i>Softstart</i>	SoftStart Function – Time in seconds during which the controller limits the MV value progressively from 0 to 100 %. It is enabled at power up or when the control output is activated. If in doubt set zero (zero value disables the Soft start function).
SPA1 SPA2 SPA3 SPA4	Alarm SP: Value that defines the point of activation for the programmed alarms with the functions “Lo” or “Hi”. For the alarms configured with Differential type functions, this parameter defines deviation (band). Not used for the other alarm functions.

RAMP AND SOAK PROFILE PROGRAMMING CYCLE

tBAS <i>Program time base</i>	Program time base - Defines the time base that will be used by all Ramp & Soak programs. SEC -Time basis in seconds min -Time basis in minutes
Pr n <i>Program number</i>	Program to be Viewed: Selects the ramp and soak profile program to be edited/viewed in the following cycle prompts (7 programs available).
Ptol <i>Program Tolerance</i>	Ramp and Soak Tolerance: maximum deviation between PV and SV. Whenever this deviation is exceeded the time counter is halted until deviation lowers to within the tolerance. Set zero to disable this function.
PSP0 PSP7 <i>Program SP</i>	Ramp and Soak Set Points: (0 to 7): Set of 8 SV values which define the ramp and soak profile segments.
Pt 1 Pt 7 <i>Program Time</i>	Ramp and Soak Segments: (1 to 7): Set of 7 time intervals in minutes for the 7 segments of the ramp and soak program.
PE 1 PE 7 <i>Program event</i>	Ramp and Soak Event: (1 to 7): Set of 7 values that define which alarms must be activated during a ramp and soak program segment. Alarm function depends on “r5” setting (Table 3).
LP <i>Link Program</i>	Link Program: number of the next profile program to be linked following the current program. 0 - Do not link to any other program. 1 to 7 - Number of the program to be linked to.

ALARM CYCLE

FUR1 FUR2 FUR3 FUR4 <i>Function Alarm</i>	Functions of Alarms. Defines the functions for the alarms among the options of the Table 3. oFF , IErr , rS , Lo , Hi , dIFL , dIFH , dIF
bLR1 bLR2 bLR3 bLR4 <i>Blocking Alarm</i>	This function blocks the alarm at power-up when the units is first energized. YES - Enables. NO - Inhibits this blocking function.
HYR1 HYR2 HYR3 HYR4 <i>Hysteresis of Alarm</i>	Defines the differential range between the PV value at which the alarm is turned on and the value at which it is turned off. (In engineering units).
Rt 1 Rt 2 Rt 3 Rt 4 <i>Alarm Time t1</i>	Defines the temporization time t1 , for the alarms. In seconds. The value 0 (zero) disables the function.
Rt 2 Rt 2 Rt 2 Rt 2 <i>Alarm Time t2</i>	Defines the temporization time t2 for the alarms time functions. In seconds. The value 0 (zero) disables the function.
FLSH	Display flashes in alarm.

CONFIGURATION CYCLE

TYPE <i>Type</i>	Input Type: Selects the input signal type to be connected to the process variable input. Refer to Table 1. This is the first parameter to be set.
FLtr	Digital Input Filter. Used to improve the stability of the measured signal (PV). Adjustable between 0 and 20. In 0 (zero) it means filter turned off and 20 means maximum filter. The higher the filter value, the slower is the response of the measured value.
dPPo <i>Decimal Point</i>	Defines the decimal point position.
un it <i>Unit</i>	Defines the indication unit in Celsius “°C” or Fahrenheit “°F” This parameter is presented whenever a temperature sensor is configured as input.
oFFS <i>Offset</i>	Sensor Offset: Offset value to be added to the PV reading to compensate sensor error. Default value: zero.



SPLL <i>Setpoint Low Limit</i>	Defines the SP lower limit of. For the linear analog input types available (0-20 mA, 4-20 mA, 0-50 mV and 0-5 V), defines the minimum PV indication range, besides limiting the SP adjustment. Defines lower limit for range retransmission PV and SP.
SPHL <i>Setpoint High Limit</i>	Defines the upper limit for adjustment of SP. For the linear analog input types available (0-20 mA, 4-20 mA, 0-50 mV and 0-5 V), defines the maximum PV indication range, besides limiting the SP adjustment. Defines upper limit for range retransmission PV and SP.
ErSP <i>Enable Remote SP</i>	Enables remote SP. YES - Enables the Function no - Does not enable the Function This parameter is not displayed when the remote SP selection is defined by a Digital Input.
rSP <i>Remote SP</i>	Defines the signal type for the remote SP. 0-20 - Current of 0-20 mA 4-20 - Current of 4-20 mA 0-5 - Voltage of 0-5 V 0-10 - Voltage of 0-10 V Parameter displayed when remote SP is enabled.
rSLL	Remote Set Point Low Limit: Selects the lower range for indication of the Remote Setpoint.
rSHL	Remote Set Point High Limit: Selects the upper range for indication of the Remote Setpoint.
IEou	Percentage output value that will be transfer to MV when the SAFE output function is enabled. If IEou = 0, the SAFE output function is disabled and the outputs are turned off in the occurrence of a sensor fail.
bAud <i>Baud Rate</i>	Serial Communication Baud Rate selection, in kbps: 1.2, 2.4, 4.8, 9.6, 19.2, 38.4, 57.6 and 115.2
Prty <i>Parity</i>	Parity of the serial communication. nonE - Without parity E:En - Even parity Odd - Odd parity
Addr <i>Address</i>	Slave Address Selection: Identifies a slave in the network. The possible address numbers are from 1 to 247.

I/O CYCLE (INPUTS AND OUTPUTS)

Io 1	I/O 1 Function: Selects the I/O function to be used at I/O 1 (relay 1). Refer to Table 2 for functions.
Io 2	I/O 2 Function: Selects the I/O function to be used at I/O 2 (relay 2). Refer to Table 2 for functions.
Io 3	I/O 3 Function: Selects the I/O function to be used at I/O 3 (relay 3). Refer to Table 2 for functions.
Io 4	I/O 4 Function: Selects the I/O function to be used at I/O 4 (relay 4). Refer to Table 2 for functions.
Io 5	I/O 5 Function: Selects the I/O function to be used at I/O 5 (relay 5). Refer to Table 2 for functions.
Io 6	I/O 6 Function: Selects the I/O function to be used at I/O 6 (relay 6). Refer to Table 2 for functions.

Ffnc	F Key Function: Selects the I/O function assigned to the front panel  key. Available functions are: oFF - Key not used; run - Start/Stop the controller (RUN function); rSP - Select remote setpoint; HPrC - Execute/Hold ramp and soak profile; Pr l - Enable/Disable ramp and soak profile 1;
-------------	--------------------------------------------------------------------------------------------------------------------------------------------------------------------------------------------------------------------------------------------------------------------------------------------------------------------------------------------------------------------------------------------------------------------------------------

CALIBRATION CYCLE

All input and output types are factory calibrated. This cycle should only be accessed by experienced personnel. If in doubt do not press the  or  keys in this cycle.

PASS <i>Password</i>	Input of the Access Password. This parameter is presented before the protected cycles. See item Protection of Configuration .
CAL Ib <i>Calibration</i>	Allows instrument calibration. YES - Perform calibration no - Do not perform calibration
inLC <i>Input Low Calibration</i>	Input Low Calibration. Enter the value corresponding to the low scale signal applied to the analog input. See section MAINTENANCE / Input Calibration.
inHC <i>Input High Calibration</i>	Input High Calibration. Enter the value corresponding to the full scale signal applied to the analog input. See section MAINTENANCE / Input Calibration.
rSLC <i>Remote SP Low Calibration</i>	Remote SP Low Calibration. Enter the value corresponding to the low scale signal applied to the remote SP input. See section MAINTENANCE / Input Calibration.
rSHC <i>Remote SP High Calibration</i>	Remote SP High Calibration. Enter the value corresponding to the full scale signal applied to the remote SP input. See section MAINTENANCE / Input Calibration.
ouLC <i>Output Low Calibration</i>	Declaration of lower value present at analog output See section MAINTENANCE / Input Calibration.
ouHC <i>Output High Calibration</i>	Declaration of upper value present at analog output. See section MAINTENANCE / Input Calibration.
rStr <i>Restore</i>	Restores the factory calibration for all input, analog output and remote SP, disregarding modifications carried out by the user.
CJ <i>Cold Junction</i>	Cold Junction Offset Calibration: Sets the cold junction offset calibration.
PASC <i>Password</i>	Allows defining a new access password (≠0).
Prot <i>Protection</i>	Sets up the Protection Level. See Table 5 .

Table 6 shows the sequence of cycles and parameters presented in the indicator display. There are parameters that must be defined for each alarm available.

OPERATION CYCLE	AUTO TUNING CYCLE	PROGRAMMING CYCLE	ALARM CYCLE	CONFIGURATION CYCLE	I/O CYCLE	CYCLE CALIBRATION
PV / SP	Autun	tbAS	FuA 1 - FuA4	tyPE	Io 1	PRSS
Auto	Pb	Pr n	bLA 1 - bLA4	FLtr	Io2	InLC
PV / MV	lr	PtoL	HYA 1 - HYA4	dPPo	Io3	InHC
Pr n	dt	PSP0 - PSP7	A It 1	un It	Io4	rSLC
P.SEG	Ct	Pt 1 - Pt 7	A It2	oFF5	Io5	rSHC
t.SEG	HYSct	PE 1 - PE 7	A2t 1	SPLL	Io6	ouLC
run	ACt	LP	A2t2	SPhL	F.Fnc	ouHC
	bIAS		FLSH	ErSP		rStr
	ouLL			rSP		CJ
	ouHL			rSLL		PRSC
	Lbdct			rSHL		Prot
	SFSct			IEou		
	SPR 1 - SPR4			bAud		
				Prty		
				Addr		

Table 6 - All the controller parameters

RAMP AND SOAK PROFILE PROGRAM

This feature allows for the elaboration of a behavior profile for the process. Each program is composed of a set of up to 7 segments, named RAMP AND SOAK PROGRAM, defined by SP values and time intervals.

When the program is defined and runs, the controller starts to automatically generate the SP according to the program.

At the end of the program execution, the controller turns the control output off ("run" = no).

Up to 7 different profiles with 7 segments each can be programmed. The figure below displays a profile model:

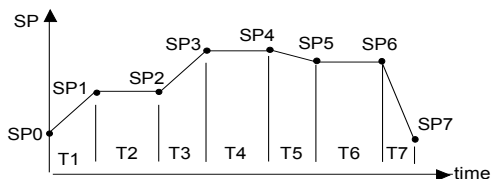

Fig. 9 - Example of a complete ramp and soak profile

To execute a profile with fewer segments just program 0 (zero) for the time intervals that follow the last segment to be executed.

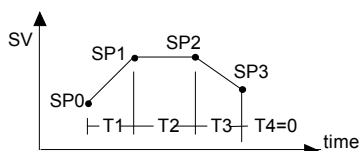

Fig. 10 - Example of a profile with fewer segments. (T4 is set 0)

The program tolerance "PtoL" defines the maximum deviation between PV and SV for the execution of the profile. If this deviation is exceeded, the program will be interrupted until the deviation falls to within the tolerance band.

Programming 0 (zero) at this prompt disables the tolerance and the profile execution will not be halted even if PV does not follow SV (time priority as opposed to SV priority).

The ramp and soak event function is used to activate alarms at any segment of program 1. This applies only to program 1.

LINK OF PROGRAMS

It is possible to create a more complex program, with up to 49 segments, joining the seven programs. This way, at the end of a program execution the controller immediately starts to run another one.

When a program is created, it must be defined in the "LP" screen whether there will be or not another program.

To make the controller run a given program or many programs continuously, it is only necessary to link a program to itself or the last program to the first.

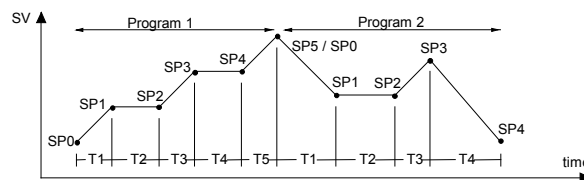

Fig. 11 - Example of two linked programs

EVENT ALARM

To enable this event function the alarms to be activated must be selected for r5 function and are programmed at the PE 1 to PE 7 prompts. The number to be programmed at the prompt defines the alarms to be activated.

Note:

1- When recovering from power outage the controller resumes the ramp and soak execution from the beginning of the interrupted segment a ramp and soak program:

- Program the tolerance value, SP's, time and event.
- If any event alarm is required program the ramp and soak event function.
- Set the control mode to automatic.
- Enable program execution in "r5" screen.
- Start control at the run prompt by selecting YES.

Before executing the program the controller waits for PV to reach the first set point SP0. Should any power failure occur the controller resumes at the beginning of the segment it currently is.

AUTO TUNE

During auto tune the process is controlled in ON/OFF mode at the programmed SetPoint (SV). Depending on the process characteristics large oscillations above and below SV may occur and auto tuning may take several minutes to be concluded.

The recommended procedure is as follows:

- Disable the control output at the **run** prompt by selecting NO.
- Select auto mode operation at the **Auto** prompt by selecting YES.
- Disable the ramp and soak function (select NO) and program a new SV value other than the present PV (close to the desired set point).
- Enable auto tuning at the **Autun** prompt by selecting YES.
- Enable the control output at the **run** prompt by selecting YES.
- The "TUNE" indicator on the display stays lit until the completion of the **automatic tuning** process.
- For control output types relay or pulse, the automatic tuning calculates the longest suitable period (cycle time **CL**) for the PWM output. The cycle time period may be reduced if the process experiences some oscillation. When driving a SSR, it's recommended to set **CL** = 1 s.
- If the automatic tuning does not result in a satisfactory control, refer to **Table 7** for guidelines on how to correct the behavior of the process.





PARAMETER	RESPONSE	SOLUTION
Proportional Band	Slow Response	Decrease
	Large Oscillation	Increase
Integral Rate	Slow Response	Increase
	Large Oscillation	Decrease
Derivative Time	Slow Response or Instability	Decrease
	Large Oscillation	Increase

Table 7 - Suggestions for manual tuning of PID parameters

CALIBRATION





INPUT CALIBRATION

All inputs are factory calibrated and recalibration should only be done by qualified personnel. If you are not familiar with these procedures do not attempt to calibrate this instrument. The calibration steps are:

- a) Select the input type to be calibrated.
- b) Set the desired upper and lower display limits.
- c) At the input terminals inject an electrical signal corresponding to a known indication value a little higher than the lower display limit.
- d) Select the **InLC** prompt. Through the  and  keys adjust PV so that it matches the injected signal.
- e) Inject a signal that corresponds to a value a little lower than the upper limit of the display.
- f) Select the **InHC** prompt. Through the  and  keys adjust PV so that it matches the injected signal.
- g) Repeat steps c) to f) to improve calibration.

Note: When checking the controller calibration with a Pt100 simulator, pay attention to the simulator minimum excitation current requirement, which may not be compatible with the 0.170 mA excitation current provided by the controller.

ANALOG OUTPUT CALIBRATION

- 1) Select type 11 or 12 at the I/O5 prompt.
- 2) Connect a current meter at the analog output.
- 3) Disable the auto-tune and soft-start functions.
- 4) Set the output low limit **ouLL** to 0.0 % and the output high limit **ouHL** to 100.0 %.
- 5) Select the manual mode at the **Auto** prompt.
- 6) Enable the output at the **run** prompt.
- 7) At the operation cycle, set the MV to 0.0 %.
- 8) At the output low calibration **ouLc** prompt, press the  and  key until the mA meter reads zero mA. Approach this value from above.
- 9) Set 100.0 % for the manipulated variable (MV).
- 10) At the output high calibration **ouHc** prompt, press the  and  key until the mA meter reads 20 mA. Approach this value from below.
- 11) Repeat steps 7) to 10) as necessary.

PROBLEMS WITH THE CONTROLLER

Connection errors and inadequate programming are the most common errors found during the controller operation. A final review may avoid loss of time and damages.

The controller displays some messages to help the user identify problems.

MESSAGE	PROBLEM
---	Open input. Without sensor or signal.
Err 1 Err 6	Configuration or connection problem in the Pt100 cable

Other error messages displayed by the controller can account for errors in the input connections or type of selected input non compliant with the sensor or signal applied to the input. If errors persist, even after a review, contact the manufacturer. Inform also the device serial number. To find out the serial number, press  for more than 3 seconds.

The controller also has a visual alarm (the display flashes) when the PV value is out of the range set by **SPHL** and **SPLL**.

SERIAL COMMUNICATION

The indicator can be supplied with an asynchronous RS-485 digital communication interface for master-slave connection to a host computer (master).

The indicator works as a slave only and all commands are started by the computer which sends a request to the slave address. The addressed unit sends back the requested reply.

Broadcast commands (addressed to all indicator units in a multidrop network) are accepted but no reply is sent back in this case.

CHARACTERISTICS

- Signals compatible with RS-485 standard. MODBUS (RTU) Protocol. Two wire connection between 1 master and up to 31 (addressing up to 247 possible) instruments in bus topology. The communication signals are electrically insulated from the rest of the device;
- Maximum connection distance: 1000 meters.
- Time of disconnection for the controller: Maximum 2 ms after last byte.
- The communication signals are electrically isolated from the rest of the instrument, and can be 1200, 2400, 4800, 9600 and 19200 bps.
- Number of data bits: 8, without parity or pair parity. Number of stop bits: 1
- Time to start response transmission: up to 100 ms after acknowledging the command.

The RS-485 signals are:

D1	D	D+	B	Bidirectional data line	Terminal 25
D0	\bar{D}	D-	A	Inverted bidirectional data line.	Terminal 26
C				Ground. Optional connection to improve communication performance	Terminal 27
GND					

COMMUNICATION PARAMETERS CONFIGURATION

Two parameters must be configured for serial use:

bAud: Communication speed. All equipments with the same speed.

Prty: Parity of the communication.

Addr: Controller communication address. Each controller must have an exclusive address.

SPECIFICATIONS

DIMENSIONS:..... 96 x 96 x 92 mm (1/4 DIN)
..... Approximate weight: 350 g

PANEL CUT-OUT: 93 x 93 mm (+0.5 -0.0 mm)

POWER: 100 to 240 Vac/dc ($\pm 10\%$), 50/60 Hz.
Transient overvoltage: ± 2 kV

Optional 24 V: 12 to 24 Vdc / 24 Vac (-10 % / +20 %)
Max. Consumption: 9 VA

ENVIRONMENTAL CONDITIONS:..... 5 to 50 °C
..... Relative humidity (maximum): 80 % up to 30 °C.
..... For temperatures above 30 °C, decrease 3 % per °C.
Installation category II. Pollution degree 2. Altitude < 2000 m

INPUT Keyboard selection of input type (refer to **Table 1**)

Internal resolution: 32767 levels

Display resolution: 12000 levels (from -1999 to 9999)

Input sample rate: 10 per second

Accuracy: Thermocouples J, K and T: 0.25 % of span ± 1 °C

..... Thermocouple E, N, R, S and B: 0.25 % of span ± 3 °C

..... Pt100: 0.2 % of span

..... 4-20 mA, 0-50 mV, 0-5 Vdc: 0.2 % of span.

Input impedance: 0-50 mV, Pt100 and thermocouples: >10 M Ω

..... 0-5 V / 0-10 V: >1 M Ω

..... 4-20 mA: 15 Ω (+2 Vdc @ 20 mA)

Pt100 measurement: standard ($\alpha=0.00385$)

Excitation current: 0.170 mA. 3-wire circuit, cable resistance compensation

All input types are factory calibrated according to IEC-584 for thermocouples and IEC-751 for Pt100.

DIGITAL INPUT: ... I/O5 AND I/O6: Dry contact or NPN open collector

ANALOG OUTPUT: I/O5: 0-20 mA or 4-20 mA, 550 Ω max.
..... 1500 levels, Isolated
..... Control output or PV or SP retransmission

CONTROL OUTPUT: .. 2 Relays SPDT (I/O1 and I/O2): 3 A / 240 Vac
..... 2 Relays SPST-NO (I/O3 and I/O4): 1.5 A / 250 Vac
..... Logic pulse for SSR drive (I/O5): 10 V max / 20 mA
..... Logic pulse for SSR drive (I/O6): 5 V max / 20 mA

SECOND ANALOG INPUT: 4-20 mA remote setpoint (standard).

AUXILIARY POWER SUPPLY: 24 Vdc, $\pm 10\%$; 25 mA

FRONT PANEL: IP65, polycarbonate UL94 V-2;

CASE: IP30, ABS+PC UL94 V-0

ELECTROMAGNETIC COMPATIBILITY:
..... EN 61326-1:1997 and EN61326-1/A1:1998

EMISSION: CISPR11/EN55011

IMMUNITY: EN61000-4-2, EN61000-4-3, EN61000-4-4, EN61000-4-5, EN61000-4-6, EN61000-4-8 and EN61000-4-11

SECURITY:
..... EN61010-1:1993 and EN61010-1/A2:1995 (UL file E300526)

USB INTERFACE: 2.0, CDC class (virtual communications port), MODBUS RTU protocol.

SPECIFIC CONNECTIONS FOR TYPE FORK TERMINALS OF 6.3 mm;

PROGRAMMABLE PWM CYCLE FROM 0.5 SEC. AND 100 SEC;

START UP: 3 seconds after power up.

CERTIFICATIONS: CE / UL (FILE: E300526)

ORDERING INFORMATION

N3000 -	485 -	24V
A	B	C

- A: Model:** **N3000;**
- B: Digital Communication:** **blank** (basic version without serial communication);
485 (RS485, Modbus protocol);
- C: Power Supply:** **blank** (basic version, 100 to 240 Vac/dc);
24V (12 to 24 Vdc / 24 Vac input voltage).

SAFETY INFORMATION

Any control system design should take into account that any part of the system has the potential to fail. This product is not a protection or safety device and its alarms are not intended to protect against product failures. Independent safety devices should be always provided if personnel or property are at risk.

Product performance and specifications may be affected by its environment and installation. It's user's responsibility to assure proper grounding, shielding, cable routing and electrical noise filtering, in accordance with local regulations, EMC standards and good installation practices.

SUPPORT AND MAINTENANCE

This product contains no serviceable parts inside. Contact our local distributor in case you need authorized service. For troubleshooting, visit our FAQ at www.novusautomation.com.

LIMITED WARRANTY AND LIMITATION OF LIABILITY

NOVUS warrants to the original purchaser that this product is free from defects in material and workmanship under normal use and service within one (1) year from the date of shipment from factory or from its official sales channel to the original purchaser.

NOVUS liability under this warranty shall not in any case exceed the cost of correcting defects in the product or of supplying replacement product as herein provided and upon the expiration of the warranty period all such liability shall terminate.

For complete information on warranty and liability limitations, check appropriate section in our website: www.novusautomation.com/warranty.