



MARATHON HEATER

STARFLEX BAND HEATERS



HEAT / COOL BANDS

COOL ONLY BANDS



5/16 diameter stainless steel coolant tubes for long life.

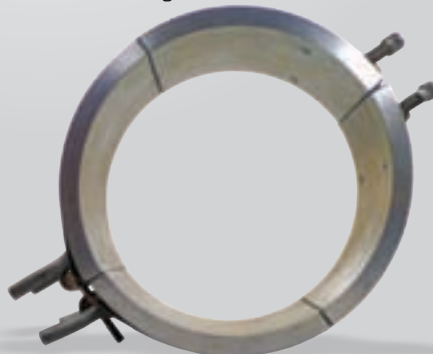

Heater and stainless steel cooling tubes.



FEATURES

Starflex heaters are manufactured by hydraulically pressing a high temperature heating element into a precision grooved aluminum channel.

The heaters are clamped in place with low expansion stainless steel straps for intimate contact with the part. The aluminum channel offers low mass and high thermal conductivity for fast heat up.

These same characteristics provide excellent cool down properties as well.

Starflex bands are also available with water cooling, both as a cool only band and a heat/cool band.

- Used on extruders, injection molding barrels, blown film dies, and other applications requiring rugged, long life heaters.
- Heaters open completely, allowing easy installation and eliminating the need to remove other items from the barrel.
- Durability of a cast-in heater at a fraction of the cost.
- They are replaceable, unlike cast in heaters that require replacement of the whole heater.



SPECIFICATIONS

• Maximum Operating Temperature	650°F
• Maximum Voltage	277 Volts Per Half
• Maximum Amps	30 Amps
• Wattage Tolerance	+5%, -10%
• Maximum Recommended Watt Density	40 Watts Per Square Inch
• Maximum Diameter	10 Ft.

Marathon Starflex are the most rugged, reliable band heater available.

Starflex band heaters are the original aluminum body band and are still the industry standard.

OPTIONS

- Strip heaters
- Box heaters
- Inside diameter heaters (reverse construction)
- Partial coverage heaters
- Terminal box
- Fiberglass leads
- Flexible stainless steel conduit
- Thermocouple holes

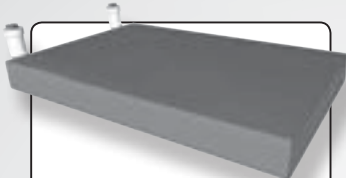

STRIP HEATERS

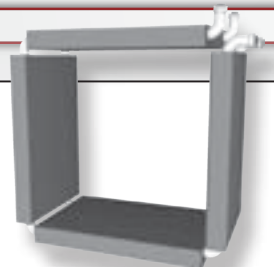

BOX HEATERS

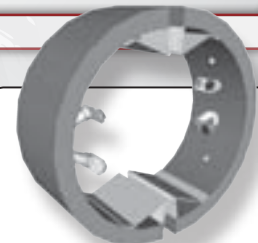

I.D. HEATERS



PARTIAL COVERAGE



TERMINAL BOX



FIBERGLASS LEADS



S.S. CONDUIT

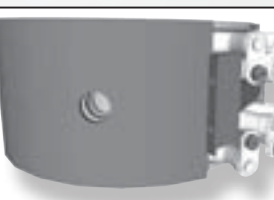

T.C. HOLES

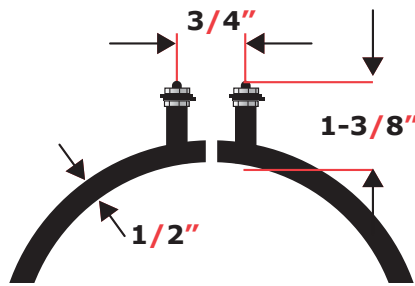

Minimum Diameter:	3.5"
Cooling Only Option:	Yes
Heat / Cool Option:	No
Optional TC Hole Size:	n/a

Width:
3/4"

Stock List			
Volts	Watts	Diameter	Part #
120 / 240	600	6 - 1/4	SF060-007A

Custom Sizes and Wattages Available.

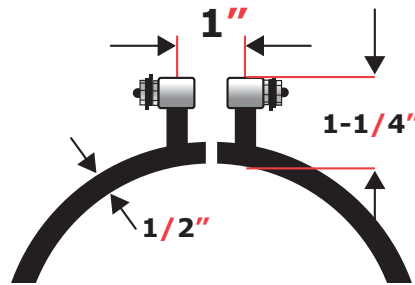

Minimum Diameter:	3.5"
Cooling Only Option:	Yes
Heat / Cool Option:	No
Optional TC Hole Size:	0.37"

Width:
1 1/2"

Stock List			
Volts	Watts	Diameter	Part #
240 / 480	875	4	SF040-015A
240 / 480	780	4 - 1/4	SF042-015A
240 / 480	600	5 - 1/4	SF052-015A
240 / 480	900	6 - 1/2	SF065-015A
240 / 480	1300	7	SF070-015A
240 / 480	1375	8 - 1/2	SF085-015A
240 / 480	1675	9	SF090-015A
240 / 480	2125	13 - 15/16	SF139-015A
240 / 480	2200	19	SF190-105A
240 / 480	2350	20	SF200-015A
240 / 480	3600	22 - 1/2	SF225-015A
240 / 480	3000	24 - 1/2	SF245-015A

Custom Sizes and Wattages Available.

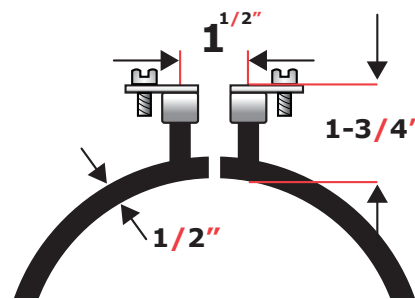

Minimum Diameter:	5"
Cooling Only Option:	No
Heat / Cool Option:	No
Optional TC Hole Size:	0.5"

Width:
2 1/2"

Stock List			
Volts	Watts	Diameter	Part #
120 / 240	350	3 - 1/2	SF035-025A
240 / 480	900	4	SF040-025A
240 / 480	1200	4 - 1/2	SF045-025A
240 / 480	800	6	SF060-025A
240 / 480	1300	6 - 3/4	SF067-025A
240 / 480	1300	6 - 7/8	SF068-025A
240 / 480	1140	7 - 1/2	SF075-025A
240 / 480	2425	9	SF090-025A
240 / 480	1500	9 - 7/8	SF097-025A
240 / 480	2375	10 - 1/4	SF102-025A
240 / 480	2125	11	SF110-025A
240 / 480	3050	11 - 7/16	SF114-025A
240 / 480	3370	12 - 3/16	SF121-025A
240 / 480	1450	12 - 1/2	SF125-025A
240 / 480	1600	12 - 5/8	SF126-025A
240 / 480	2375	12 - 5/8	SF126-025B
240 / 480	3000	12 - 5/8	SF126-025C
240 / 480	3575	13	SF130-025A
240 / 480	3275	13 - 3/16	SF131-025A
240 / 480	3000	14	SF140-025A
240 / 480	2725	14 - 15/16	SF149-025A
240 / 480	3725	14 - 15/16	SF149-025B
240 / 480	2300	15 - 3/16	SF151-025A

Custom Sizes and Wattages Available.

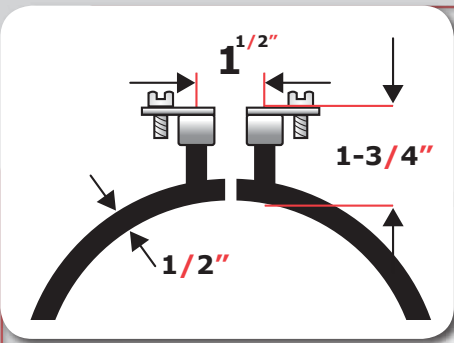

Minimum Diameter:	5
Cooling Only Option:	Yes
Heat / Cool Option:	Yes
Optional TC Hole Size:	0.5"

Width:
3"

Stock List			
Volts	Watts	Diameter	Part #
240 / 480	2000	10	SF100-030A
240 / 480	3250	11 - 1/2	SF115-030A
240 / 480	3535	15	SF150-030A
240 / 480	5400	19	SF190-030A

Custom Sizes and Wattages Available.

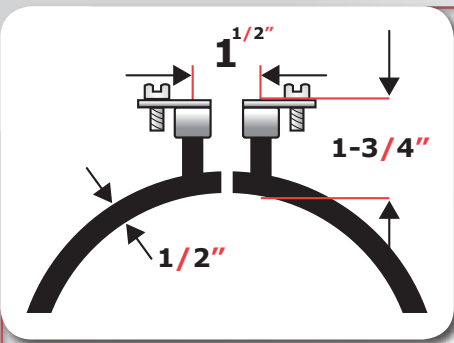

Minimum Diameter:	5
Cooling Only Option:	Yes
Heat / Cool Option:	Yes
Optional TC Hole Size:	0.5"

Width:
4"

CUSTOM DESIGNS ONLY



Your Authorized Marathon Heater Representative is:

Marathon Heater 808 Hackberry Ln., Del Rio, TX, 78840. **Phone:** (830)-775-1417 **FAX:** (830)-775-4379
www.marathonheater.com sales@marathonheater.com

Download our latest brochures at <http://www.marathonheater.com>
 BR-STR-12 Revised 18 January 2012 © Marathon Heater Inc. All Rights Reserved.



Calculator

Main Site