

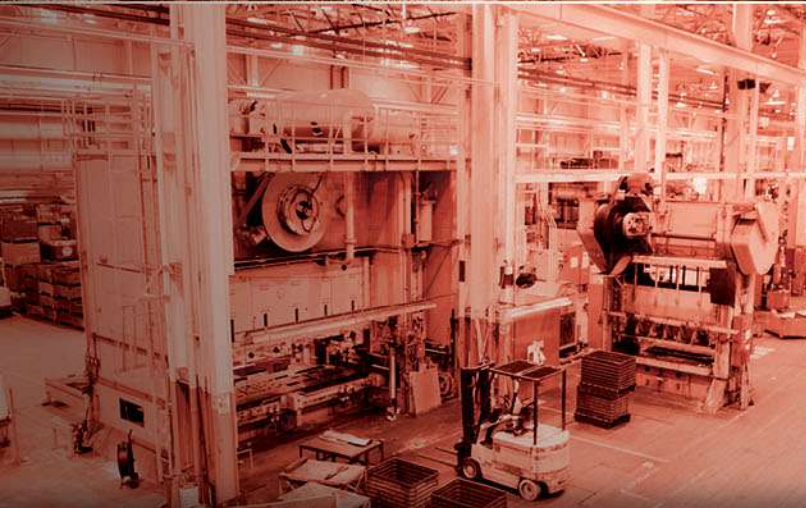

# HTM<sup>TM</sup>

## SENSORS

SERVING THE OWNERS OF AUTOMATED MACHINERY  
WITH WORLD CLASS SENSORS AND DOWNTIME  
REDUCTION SERVICES TO APPLY THEM

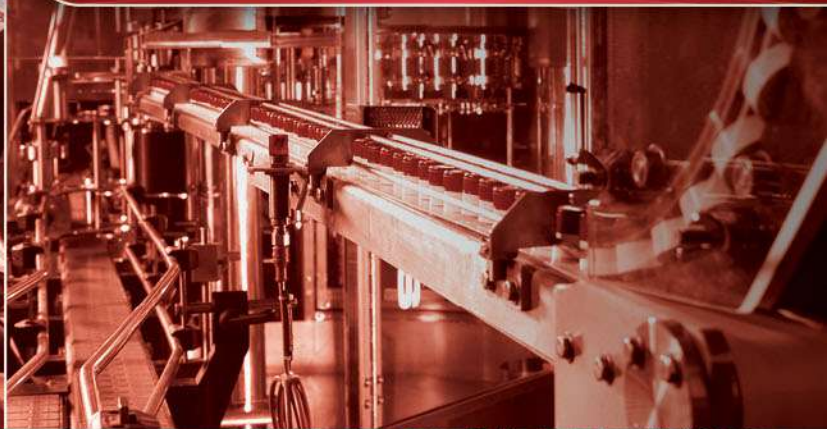



# IT'S ALIVE!

Introducing **NEW** MonsterProx™ Sensors  
High Temperature Coated WFI MetalHead™ Sensors with a  
Super Durable American Made Barrel



For Your Toughest Jobs,  
Send In The MONSTER!

# MONSTER PROX™



Assembled in U.S.A. Made in Canada

HTM SENSORS



PRODUCT GUIDE



**PROXIMITY SENSORS 4-33**

STANDARD RANGE PROXIMITY SENSORS..... 4-5  
 EXTENDED RANGE PROXIMITY SENSORS..... 6-7  
 LONG RANGE PROXIMITY SENSORS ..... 8-9  
 AUTOMOTIVE GENERAL PURPOSE SENSORS..... 10-11  
 WELD FIELD IMMUNE PROXIMITY SENSORS ..... 12-13  
 METALHEAD™ PROXIMITY SENSORS..... 14-15  
 METALHEAD™ FOOD GRADE SENSORS ..... 16-17  
 TITANPROX™ 1-PIECE TITANIUM..... 18-19  
 METALHEAD™ SENSORS WITH SPATTERGUARD™ ..... 20-21  
 HIGH TEMPERATURE WFI METALHEAD™ SENSORS..... 22-23  
 METALHEAD™ FLATPACK SENSORS..... 24-27  
 MINI FIXED-MOUNT SENSORS ..... 28-29  
 MINIATURE INDUCTIVE PROXIMITY SENSORS ..... 30-31  
 INDUCTIVE RING PROXIMITY SENSORS ..... 32-33



**CAPACITIVE SENSORS 34-35**

CAPACITIVE PROXIMITY SENSORS ..... 34-35



**PHOTOELECTRIC SENSORS 36-41**

M18 PHOTOELECTRIC SENSORS ..... 36-37  
 IP69K STAINLESS STEEL PHOTOELECTRIC SENSORS ..... 38-39  
 RP74 - PHOTOELECTRIC SENSORS ..... 40-41



**SAFETY LIGHT CURTAINS 42-43**

SAFETY LIGHT CURTAINS - CATEGORY 4 HAND PROTECTION ..... 42-43



**CABLES AND CONNECTORS 44-53**

QUICK-CONNECT SENSOR CABLES - M8..... 44-45  
 QUICK-CONNECT SENSOR CABLES - M12..... 46-47  
 FACTORY PRE-INSTALLED SILICONE CABLES ..... 48-49  
 FIELD CONNECTORS..... 50-51  
 SENSOR CONNECTION DISTRIBUTION BLOCKS..... 52-53



**PNEUMATIC SENSORS 54-55**

PNEUMATIC CYLINDER SENSORS..... 54-55



**SENSOR PROTECTION 56-59**

SENSOR PROTECTION DEVICES ..... 56-57  
 SILICONE WELD SPATTER PROTECTION ..... 58-59



**HTM**<sup>TM</sup>  
**SENSORS**



- STANDARD RANGE SENSORS FOR THE DETECTION OF METAL TARGETS
- LOWEST PRICE OF ALL THE MAJOR BRANDS FOR STANDARD SENSORS
- 1,000'S IN STOCK FOR SAME DAY DELIVERY
- STANDARD LIFETIME WARRANTY AGAINST DEFECTS
- RELIABLE NON-CONTACT OPERATION FOR MANY TYPES OF MACHINES
- IDEAL FOR USE WHERE A LOW-COST SENSOR IS NEEDED FOR DETECTION





# STANDARD RANGE PROXIMITY SENSORS SPECIFICATIONS



SENSING DISTANCE	1 mm	1 mm	2 mm	5 mm	10 mm
OPERATING VOLTAGE	10-30 VDC				
OPERATING TEMPERATURE	-25 °C - +70 °C				
HOUSING MATERIAL	Stainless Steel	Chrome Plated Brass			
<b>PART NUMBERS</b>					
DC 3-wire 10-30 V PNP - Open	FCU1-0801P-ACU3	FCM1-0801P-ARU4	FCM1-1202P-ARU4	FCM1-1805P-ARU4	FCM1-3010P-ARU4
DC 3-wire 10-30 V PNP - Closed	FCU1-0801P-BCU3	FCM1-0801P-BRU4	FCM1-1202P-BRU4	FCM1-1805P-BRU4	FCM1-3010P-BRU4
DC 3-wire 10-30 V NPN - Open	FCU1-0801N-ACU3	FCM1-0801N-ARU4	FCM1-1202N-ARU4	FCM1-1805N-ARU4	FCM1-3010N-ARU4
DC 3-wire 10-30 V NPN - Closed	FCU1-0801N-BCU3	FCM1-0801N-BRU4	FCM1-1202N-BRU4	FCM1-1805N-BRU4	FCM1-3010N-BRU4
DC 2-wire 10-30 V - Open	FCU1-0801C-ACU3	FCM1-0801C-ARU4	FCM1-1202C-ARU4	FCM1-1805C-ARU4	FCM1-3010C-ARU4
DC 2-wire 10-30 V - Closed	FCU1-0801C-BCU3	FCM1-0801C-BRU4	FCM1-1202C-BRU4	FCM1-1805C-BRU4	FCM1-3010C-BRU4

STANDARD RANGE SENSORS HAVE THE BEST PRICE OF ALL THE MAJOR BRANDS FOR APPLICATIONS THAT REQUIRE A RELIABLE AND LOW-COST SENSOR.





**HTM**<sup>TM</sup>  
**SENSORS**

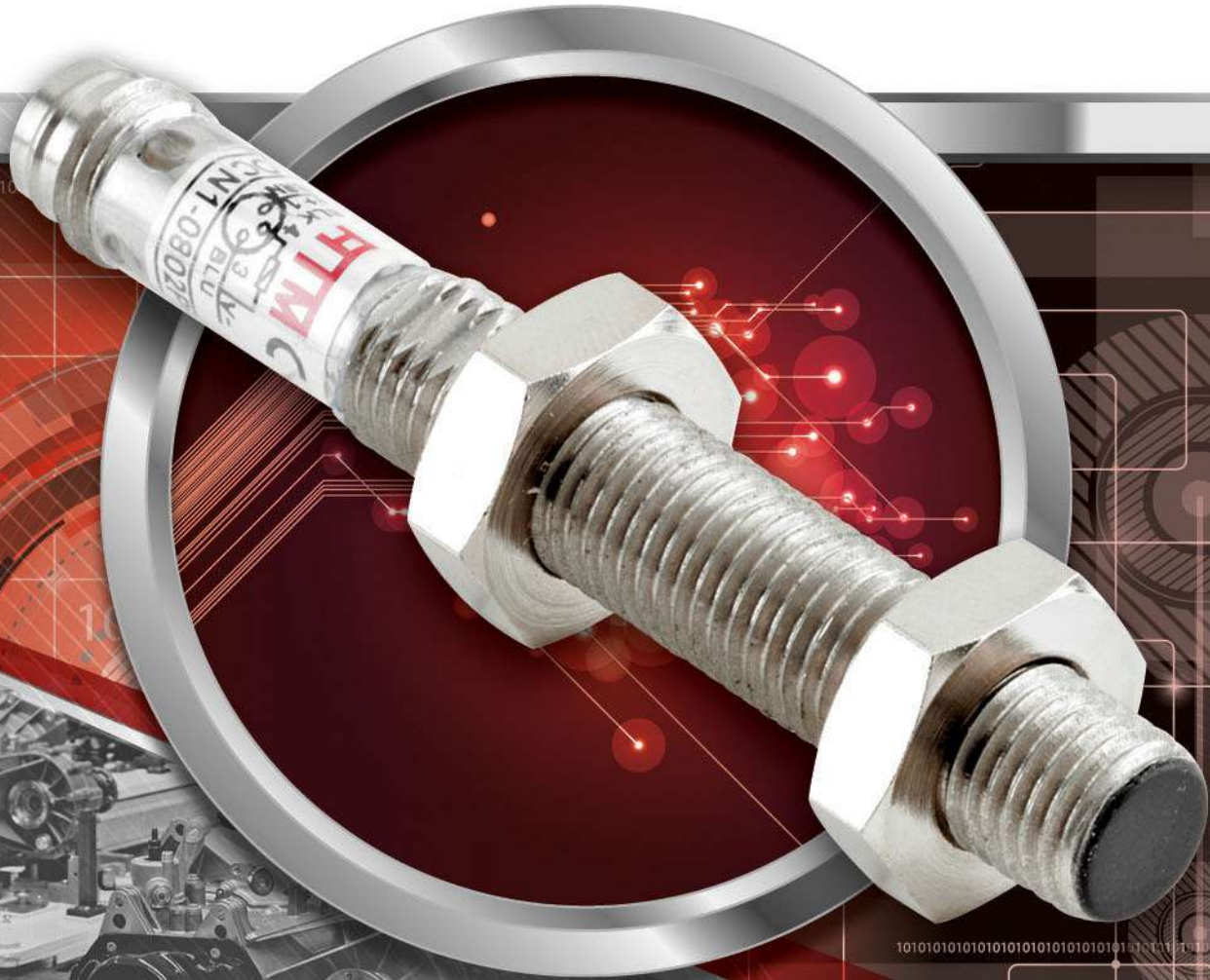

- EXTENDED RANGE SENSORS FOR AUTOMATED MACHINERY
- DOUBLE THE RANGE OF STANDARD SENSORS FOR RELIABLE DETECTION
- TIGHT HYSTERESIS FOR A REPEATABLE SENSING RANGE
- HIGH-TORQUE BARREL IS EXTRA THICK FOR MORE DURABILITY
- WRENCH FLATS AND 4-VIEW LED FOR EASY INSTALLATION
- IDEAL FOR USE IN ALL TYPES OF MACHINES FOR PART DETECTION





# EXTENDED RANGE PROXIMITY SENSORS SPECIFICATIONS



SENSING DISTANCE	2 mm	2 mm	4 mm	8 mm	15 mm
OPERATING VOLTAGE	10-30 VDC				
OPERATING TEMPERATURE	-25 °C - +70 °C				
HOUSING MATERIAL	Stainless Steel		Chrome Plated Brass		
<b>PART NUMBERS</b>					
DC 3-wire 10-30 V PNP - Open	OCN1-0802P-ACL3	OCN1-0802P-ARL4	OCN1-1204P-ARL4	OCN1-1808P-ARL4	OCN1-3015P-ARL4
DC 3-wire 10-30 V PNP - Closed	OCN1-0802P-BCL3	OCN1-0802P-BRL4	OCN1-1204P-BRL4	OCN1-1808P-BRL4	OCN1-3015P-BRL4
DC 3-wire 10-30 V NPN - Open	OCN1-0802N-ACL3	OCN1-0802N-ARL4	OCN1-1204N-ARL4	OCN1-1808N-ARL4	OCN1-3015N-ARL4
DC 3-wire 10-30 V NPN - Closed	OCN1-0802N-BCL3	OCN1-0802N-BRL4	OCN1-1204N-BRL4	OCN1-1808N-BRL4	OCN1-3015N-BRL4
DC 2-wire 10-30 V - Open	OCN1-0802C-ACL3	OCN1-0802C-ARL4	OCN1-1204C-ARL4	OCN1-1808C-ARL4	OCN1-3015C-ARL4
DC 2-wire 10-30 V - Closed	OCN1-0802C-BCL3	OCN1-0802C-BRL4	OCN1-1204C-BRL4	OCN1-1808C-BRL4	OCN1-3015C-BRL4

EXTENDED RANGE SENSORS ARE THE BEST VALUE IN THE SENSOR LINE UP WITH GREAT PERFORMANCE FEATURES, EXTENDED RANGE, MORE DURABILITY AND A LOW PRICE FOR ALL APPLICATIONS.





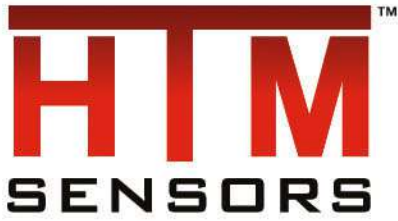

- LONG RANGE SENSORS FOR AUTOMATED MACHINERY
- UP TO 3 TIMES THE STANDARD RANGE FOR RELIABLE DETECTION
- ALLOWS THE SENSOR TO BE MOUNTED FURTHER AWAY TO AVOID CONTACT
- GREAT FOR ANGLED PARTS WHERE THE TARGET CAN BE A VARIABLE DISTANCE
- AVAILABLE WITH A PRE-WIRED CABLE, PIGTAIL, OR QUICK-CONNECTOR
- IDEAL FOR USE IN MACHINES WHERE THE TARGET IS FURTHER AWAY





# LONG RANGE PROXIMITY SENSORS SPECIFICATIONS



SENSING DISTANCE	3 mm	3 mm	6 mm	12 mm	22 mm
OPERATING VOLTAGE	10-30 VDC				
OPERATING TEMPERATURE	-25 °C - +70 °C				
HOUSING MATERIAL	Stainless Steel		Chrome Plated Brass		
Shielded					
DC 3-wire 10-30 V PNP - Open	LCN1-0803P-ACL3	LCN1-0803P-ARL4	LCN1-1206P-ARL4	LCN1-1812P-ARL4	LCN1-3022P-ARL4
DC 3-wire 10-30 V PNP - Closed	LCN1-0803P-BCL3	LCN1-0803P-BRL4	LCN1-1206P-BRL4	LCN1-1812P-BRL4	LCN1-3022P-BRL4
DC 3-wire 10-30 V NPN - Open	LCN1-0803N-ACL3	LCN1-0803N-ARL4	LCN1-1206N-ARL4	LCN1-1812N-ARL4	LCN1-3022N-ARL4
DC 3-wire 10-30 V NPN - Closed	LCN1-0803N-BCL3	LCN1-0803N-BRL4	LCN1-1206N-BRL4	LCN1-1812N-BRL4	LCN1-3022N-BRL4
Quasi Shielded Sensing Range	4 mm	4 mm	8 mm	16 mm	25 mm
DC 3-wire 10-30 V PNP - Open	LCN1-0804P-ACL3	LCN1-0804P-ARL4	LCN1-1208P-ARL4	LCN1-1816P-ARL4	LCN1-3025P-ARL4
DC 3-wire 10-30 V NPN - Open	LCN1-0804N-ACL3	LCN1-0804N-ARL4	LCN1-1208N-ARL4	LCN1-1816N-ARL4	LCN1-3025N-ARL4

LONG RANGE PROXIMITY SENSORS ARE THE BEST CHOICE FOR AUTOMATED MACHINERY WHERE A LONGER RANGE IS REQUIRED FOR REPEATABLE OPERATION, AND WHERE CONTACT NEEDS TO BE AVOIDED FROM PARTS OR TOOLING.





**HTM**<sup>TM</sup>  
**SENSORS**



- DOUBLE RANGE SENSORS FOR USE IN AUTOMOTIVE APPLICATIONS
- HIGH TORQUE BARREL CONSTRUCTION FOR RUGGED OPERATION
- WRENCH FLATS FOR EASY INSTALLATION AND A TIGHT FIT
- SPATTERGUARD™ PTFE COATING TO RESIST WELD SPATTER DAMAGE
- 100 °C RATING FOR HOT WELDING AREAS
- AVAILABLE IN PNP, NPN, AC, AND DC 2-WIRE OUTPUT FUNCTIONS





# AUTOMOTIVE GENERAL PURPOSE SENSORS SPECIFICATIONS



SENSING DISTANCE	2 mm	2 mm	4 mm	8 mm	15 mm
OPERATING VOLTAGE	10-30 VDC				
OPERATING TEMPERATURE	-25 °C - +100 °C				
HOUSING MATERIAL	PTFE Coated Stainless Steel		PTFE Coated Brass		
<b>PART NUMBERS</b>					
DC 3-wire 10-30 V PNP - Open	OCN1-0802P-ACL3-PTFE-100C	OCN1-0802P-ARL4-PTFE-100C	OCN1-1204P-ARL4-PTFE-100C	OCN1-1808P-ARL4-PTFE-100C	OCN1-3015P-ARL4-PTFE-100C
DC 3-wire 10-30 V PNP - Closed	OCN1-0802P-BCL3-PTFE-100C	OCN1-0802P-BRL4-PTFE-100C	OCN1-1204P-BRL4-PTFE-100C	OCN1-1808P-BRL4-PTFE-100C	OCN1-3015P-BRL4-PTFE-100C
DC 3-wire 10-30 V NPN - Open	OCN1-0802N-ACL3-PTFE-100C	OCN1-0802N-ARL4-PTFE-100C	OCN1-1204N-ARL4-PTFE-100C	OCN1-1808N-ARL4-PTFE-100C	OCN1-3015N-ARL4-PTFE-100C
DC 3-wire 10-30 V NPN - Closed	OCN1-0802N-BCL3-PTFE-100C	OCN1-0802N-BRL4-PTFE-100C	OCN1-1204N-BRL4-PTFE-100C	OCN1-1808N-BRL4-PTFE-100C	OCN1-3015N-BRL4-PTFE-100C
DC 2-wire 10-30 V - Open	OCN1-0802C-ACL3-PTFE-100C	OCN1-0802C-ARL4-PTFE-100C	OCN1-1204C-ARL4-PTFE-100C	OCN1-1808C-ARL4-PTFE-100C	OCN1-3015C-ARL4-PTFE-100C
DC 2-wire 10-30 V - Closed	OCN1-0802C-BCL3-PTFE-100C	OCN1-0802C-BRL4-PTFE-100C	OCN1-1204C-BRL4-PTFE-100C	OCN1-1808C-BRL4-PTFE-100C	OCN1-3015C-BRL4-PTFE-100C

GENERAL PURPOSE AUTOMOTIVE SENSORS ARE THE BEST CHOICE FOR TOOLING AND ASSEMBLY FIXTURES, SPOT WELDING MACHINES, AND MIG WELDING CELLS WHERE A RELIABLE, COST-EFFECTIVE SENSOR IS REQUIRED FOR SENSING APPLICATIONS.





**HTM**<sup>TM</sup>  
**SENSORS**

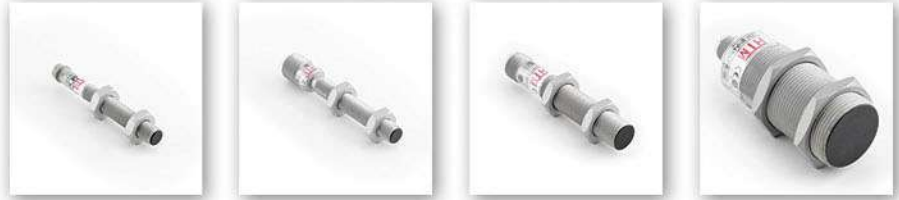

- WELD FIELD IMMUNE SENSORS FOR MIG AND SPOT WELDING MACHINES
- HIGH TORQUE BARREL WITH WRENCH FLATS FOR A TIGHT FIT
- SPATTERGUARD™ PTFE COATING TO RESIST WELD SPATTER DAMAGE
- 100 °C RATING FOR HOT WELDING ENVIRONMENTS
- AVAILABLE IN PNP, NPN AND AC OUTPUT FUNCTIONS
- IDEAL FOR USE IN HOT WELDING ENVIRONMENTS WITH WELD SPATTER





# WELD FIELD IMMUNE PROXIMITY SENSORS SPECIFICATIONS



SENSING DISTANCE	2 mm	2 mm	4 mm	8 mm	15 mm
OPERATING VOLTAGE	10-30 VDC				
OPERATING TEMPERATURE	-25 °C - +100 °C				
HOUSING MATERIAL	PTFE Coated Brass				
<b>PART NUMBERS</b>					
DC 3-wire 10-30 V PNP - Open	WCN1-0802P-ACL3-PTFE-100C	WCN1-0802P-ARL4-PTFE-100C	WCN1-1204P-ARL4-PTFE-100C	WCN1-1808P-ARL4-PTFE-100C	WCN1-3015P-ARL4-PTFE-100C
DC 3-wire 10-30 V PNP - Closed	WCN1-0802P-BCL3-PTFE-100C	WCN1-0802P-BRL4-PTFE-100C	WCN1-1204P-BRL4-PTFE-100C	WCN1-1808P-BRL4-PTFE-100C	WCN1-3015P-BRL4-PTFE-100C
DC 3-wire 10-30 V NPN - Open	WCN1-0802N-ACL3-PTFE-100C	WCN1-0802N-ARL4-PTFE-100C	WCN1-1204N-ARL4-PTFE-100C	WCN1-1808N-ARL4-PTFE-100C	WCN1-3015N-ARL4-PTFE-100C
DC 3-wire 10-30 V NPN - Closed	WCN1-0802N-BCL3-PTFE-100C	WCN1-0802N-BRL4-PTFE-100C	WCN1-1204N-BRL4-PTFE-100C	WCN1-1808N-BRL4-PTFE-100C	WCN1-3015N-BRL4-PTFE-100C
DC 2-wire 10-30 V - Open	WCN1-0802C-ACL3-PTFE-100C	WCN1-0802C-ARL4-PTFE-100C	WCN1-1204C-ARL4-PTFE-100C	WCN1-1808C-ARL4-PTFE-100C	WCN1-3015C-ARL4-PTFE-100C
DC 2-wire 10-30 V - Closed	WCN1-0802C-BCL3-PTFE-100C	WCN1-0802C-BRL4-PTFE-100C	WCN1-1204C-BRL4-PTFE-100C	WCN1-1808C-BRL4-PTFE-100C	WCN1-3015C-BRL4-PTFE-100C

WELD FIELD IMMUNE SENSORS ARE THE BEST CHOICE FOR MIG AND SPOT WELDING MACHINERY WHERE A RELIABLE SENSOR IS REQUIRED FOR RELIABLE OPERATION AROUND HIGH HEAT, WELD SPATTER AND HIGH MAGNETIC FIELDS.





**HTM**<sup>TM</sup>  
SENSORS



- DURABLE 1-PIECE STAINLESS STEEL CONSTRUCTION
- MADE FROM STAINLESS STEEL BAR, TURNED, AND BORED OUT FROM THE END
- SEALED AGAINST LIQUID, OIL, AND DUST FOR MAINTENANCE-FREE OPERATION
- LASTS LONGER THAN PLASTIC FACE SENSORS WHERE CONTACT IS FREQUENT
- IDEAL FOR USE WHERE A MORE DURABLE SENSOR IS REQUIRED FOR LESS DOWNTIME





# METALHEAD™ PROXIMITY SENSORS SPECIFICATIONS



SENSING DISTANCE	1 mm	1 mm	2 mm	5 mm	10 mm
OPERATING VOLTAGE	10-30 VDC				
OPERATING TEMPERATURE	-25 °C - +70 °C				
HOUSING MATERIAL	1-piece Stainless Steel Face and Body				
<b>PART NUMBERS</b>					
DC 3-wire 10-30 V PNP - Open	FCS1-0801P-ACS3	FCS1-0801P-ARU4	FCS1-1202P-ARU4	FCS1-1805P-ARU4	FCS1-3010P-ARU4
DC 3-wire 10-30 V PNP - Closed	FCS1-0801P-BCS3	FCS1-0801P-BRU4	FCS1-1202P-BRU4	FCS1-1805P-BRU4	FCS1-3010P-BRU4
DC 3-wire 10-30 V NPN - Open	FCS1-0801N-ACS3	FCS1-0801N-ARU4	FCS1-1202N-ARU4	FCS1-1805N-ARU4	FCS1-3010N-ARU4
DC 3-wire 10-30 V NPN - Closed	FCS1-0801N-BCS3	FCS1-0801N-BRU4	FCS1-1202N-BRU4	FCS1-1805N-BRU4	FCS1-3010N-BRU4
DC 2-wire 10-30 V - Open	FCS1-0801C-ACS3	FCS1-0801C-ARU4	FCS1-1202C-ARU4	FCS1-1805C-ARU4	FCS1-3010C-ARU4
AC 110-220 V - Open	N/A	N/A	FCS1-1202A-AUL3	FCS1-1805A-AUL3	FCS1-3010A-AUL3

METALHEAD™ SENSORS ARE MADE OF 1-PIECE OF STAINLESS STEEL BAR, BORED OUT FROM THE END FOR SUPERIOR STRENGTH AND DURABILITY.





**HTM**<sup>TM</sup>  
SENSORS



- 1-PIECE STAINLESS STEEL SENSORS FOR FOOD AND PACKAGING APPLICATIONS
- MADE OF 1-PIECE OF SUS 316 FOOD GRADE STAINLESS STEEL BAR
- DOUBLE THE RANGE FROM STANDARD, THE M12 HAS A 4 mm RANGE
- 100 °C RATING FOR HOT FOOD PRODUCTION OR CLEANING
- AVAILABLE IN PNP, NPN, DC 2-WIRE AND AC OUTPUT FUNCTIONS
- IDEAL FOR USE WHERE PRESSURE WASHDOWN AND DETERGENTS ARE USED





# METALHEAD™ FOOD GRADE SENSORS SPECIFICATIONS



SENSING DISTANCE	2 mm	2 mm	4 mm	8 mm	15 mm
OPERATING VOLTAGE	10-30 VDC				
OPERATING TEMPERATURE	-25 °C - +100 °C				
HOUSING MATERIAL	1-piece Stainless Steel Face and Body - Food Grade SUS 316				
<b>PART NUMBERS</b>					
DC 3-wire 10-30 V PNP - Open	ECS1-0802P-ACS3-100C-316	ECS1-0802P-ARU4-100C-316	ECS1-1204P-ARU4-100C-316	ECS1-1808P-ARU4-100C-316	ECS1-3015P-ARU4-100C-316
DC 3-wire 10-30 V PNP - Closed	ECS1-0802P-BCS3-100C-316	ECS1-0802P-BRU4-100C-316	ECS1-1204P-BRU4-100C-316	ECS1-1808P-BRU4-100C-316	ECS1-3015P-BRU4-100C-316
DC 3-wire 10-30 V NPN - Open	ECS1-0802N-ACS3-100C-316	ECS1-0802N-ARU4-100C-316	ECS1-1204N-ARU4-100C-316	ECS1-1808N-ARU4-100C-316	ECS1-3015N-ARU4-100C-316
DC 3-wire 10-30 V NPN - Closed	ECS1-0802N-BCS3-100C-316	ECS1-0802N-BRU4-100C-316	ECS1-1204N-BRU4-100C-316	ECS1-1808N-BRU4-100C-316	ECS1-3015N-BRU4-100C-316
DC 2-wire 10-30 V - Open	ECS1-0802C-ACS3-100C-316	ECS1-0802C-ARU4-100C-316	ECS1-1204C-ARU4-100C-316	ECS1-1808C-ARU4-100C-316	ECS1-3015C-ARU4-100C-316
AC 110-220 V - Open	N/A	N/A	ECS1-1204A-AUL3-100C-316	ECS1-1808A-AUL3-100C-316	ECS1-3015A-AUL3-100C-316

FOOD GRADE METALHEAD™ SENSORS ARE THE BEST CHOICE FOR FOOD AND PACKAGING MACHINERY WHERE A RELIABLE AND COMPLETELY SEALED SENSOR IS REQUIRED FOR LONG-LASTING OPERATION IN A TOUGH ENVIRONMENT.





**HTM**<sup>TM</sup>  
SENSORS



# Titan **PROX**<sup>TM</sup>

1-PIECE TITANIUM



- 1-PIECE TC4 TITANIUM SENSORS FOR SUPERIOR STRENGTH AND DURABILITY
- MADE OF 1-PIECE OF BORED TC4 TITANIUM BAR
- DOUBLE THE RANGE FROM STANDARD, THE M12 HAS A 4 mm RANGE
- 100 °C RATING FOR HOT APPLICATION ENVIRONMENTS
- AVAILABLE IN PNP, NPN, DC 2-WIRE, AND AC OUTPUT FUNCTIONS
- IDEAL FOR USE WHERE EXTREME STRENGTH AND DURABILITY IS REQUIRED





# TitanPROX™

1-PIECE TITANIUM



SENSING DISTANCE	2 mm	2 mm	4 mm	8 mm	15 mm
OPERATING VOLTAGE	10-30 VDC				
OPERATING TEMPERATURE	-25 °C - +100 °C				
HOUSING MATERIAL	1-piece TC4 Titanium Face and Body				
<b>PART NUMBERS</b>					
DC 3-wire 10-30 V PNP - Open	ECS1-0802P-ACS3-100C-TC4	ECS1-0802P-ARU4-100C-TC4	ECS1-1204P-ARU4-100C-TC4	ECS1-1808P-ARU4-100C-TC4	ECS1-3015P-ARU4-100C-TC4
DC 3-wire 10-30 V PNP - Closed	ECS1-0802P-BCS3-100C-TC4	ECS1-0802P-BRU4-100C-TC4	ECS1-1204P-BRU4-100C-TC4	ECS1-1808P-BRU4-100C-TC4	ECS1-3015P-BRU4-100C-TC4
DC 3-wire 10-30 V NPN - Open	ECS1-0802N-ACS3-100C-TC4	ECS1-0802N-ARU4-100C-TC4	ECS1-1204N-ARU4-100C-TC4	ECS1-1808N-ARU4-100C-TC4	ECS1-3015N-ARU4-100C-TC4
DC 3-wire 10-30 V NPN - Closed	ECS1-0802N-BCS3-100C-TC4	ECS1-0802N-BRU4-100C-TC4	ECS1-1204N-BRU4-100C-TC4	ECS1-1808N-BRU4-100C-TC4	ECS1-3015N-BRU4-100C-TC4
DC 2-wire 10-30 V - Open	ECS1-0802C-ACS3-100C-TC4	ECS1-0802C-ARU4-100C-TC4	ECS1-1204C-ARU4-100C-TC4	ECS1-1808C-ARU4-100C-TC4	ECS1-3015C-ARU4-100C-TC4
AC 110-220 V - Open	N/A	N/A	ECS1-1204A-AUL3-100C-TC4	ECS1-1808A-AUL3-100C-TC4	ECS1-3015A-AUL3-100C-TC4

TITANPROX™ SENSORS ARE MADE FROM ONE PIECE OF TITANIUM FOR THE STRONGEST AND MOST DURABLE SENSOR HOUSINGS AVAILABLE ON THE MARKET.





**HTM**<sup>TM</sup>  
SENSORS



- HARSH DUTY SENSORS FOR WELDING ENVIRONMENTS
- 1-PIECE STAINLESS STEEL FACE AND BODY CONSTRUCTION
- PTFE COATED FOR WELD SPATTER RESISTANCE
- 100 °C RATED FOR HOT WELD CELLS
- EXTENDED RANGE FOR RELIABLE DETECTION
- AVAILABLE WITH PNP, NPN, AND AC OUTPUT FUNCTIONS





# METALHEAD™ SENSORS WITH SPATTERGUARD™ SPECIFICATIONS



SENSING DISTANCE	2 mm	2 mm	4 mm	8 mm	15 mm
OPERATING VOLTAGE	10-30 VDC				
OPERATING TEMPERATURE	-25 °C - +100 °C				
HOUSING MATERIAL	1-piece Face and Body - PTFE Coated Stainless Steel				
<b>PART NUMBERS</b>					
WELD FIELD IMMUNE PNP - Open	WCS1-0802P-ACS3-PTFE-100C	WCS1-0802P-ARU4-PTFE-100C	WCS1-1204P-ARU4-PTFE-100C	WCS1-1808P-ARU4-PTFE-100C	WCS1-3015P-ARU4-PTFE-100C
DC 3-wire 10-30 V PNP - Open	ECS1-0802P-ACS3-PTFE-100C	ECS1-0802P-ARU4-PTFE-100C	ECS1-1204P-ARU4-PTFE-100C	ECS1-1808P-ARU4-PTFE-100C	ECS1-3015P-ARU4-PTFE-100C
DC 3-wire 10-30 V PNP - Closed	ECS1-0802P-BCS3-PTFE-100C	ECS1-0802P-BRU4-PTFE-100C	ECS1-1204P-BRU4-PTFE-100C	ECS1-1808P-BRU4-PTFE-100C	ECS1-3015P-BRU4-PTFE-100C
DC 3-wire 10-30 V NPN - Open	ECS1-0802N-ACS3-PTFE-100C	ECS1-0802N-ARU4-PTFE-100C	ECS1-1204N-ARU4-PTFE-100C	ECS1-1808N-ARU4-PTFE-100C	ECS1-3015N-ARU4-PTFE-100C
DC 3-wire 10-30 V NPN - Closed	ECS1-0802N-BCS3-PTFE-100C	ECS1-0802N-BRU4-PTFE-100C	ECS1-1204N-BRU4-PTFE-100C	ECS1-1808N-BRU4-PTFE-100C	ECS1-3015N-BRU4-PTFE-100C
DC 2-wire 10-30 V - Open	ECS1-0802C-ACS3-PTFE-100C	ECS1-0802C-ARU4-PTFE-100C	ECS1-1204C-ARU4-PTFE-100C	ECS1-1808C-ARU4-PTFE-100C	ECS1-3015C-ARU4-PTFE-100C
AC 110-220 V - Open	N/A	N/A	ECS1-1204A-AUL3-PTFE-100C	ECS1-1808A-AUL3-PTFE-100C	ECS1-3015A-AUL3-PTFE-100C

METALHEAD™ SENSORS WITH SPATTERGUARD™ ARE THE BEST CHOICE FOR AUTOMATED WELD CELLS WHERE A MORE DURABLE SENSOR IS REQUIRED TO REDUCE DOWNTIME.





HIGH TEMPERATURE WELD FIELD IMMUNE  
METALHEAD™ SENSORS

**HTM**<sup>TM</sup>  
SENSORS



- HARSH DUTY SENSORS FOR WELDING ENVIRONMENTS
- 1-PIECE STAINLESS STEEL OR TITANIUM FACE AND BODY CONSTRUCTION
- BLACK SPATTERGUARD™ COATING FOR WELD SPATTER RESISTANCE
- 120 °C RATED FOR HOT WELD CELLS
- EXTENDED RANGE FOR RELIABLE DETECTION
- WELD FIELD IMMUNE CIRCUITRY





# HIGH TEMPERATURE WELD FIELD IMMUNE METALHEAD™ SENSORS SPECIFICATIONS



SENSING DISTANCE	2 mm	2 mm	4 mm	8 mm	15 mm
OPERATING VOLTAGE	10-30 VDC				
OPERATING TEMPERATURE	-25 °C - +120 °C				
HOUSING MATERIAL	1-piece Face and Body - Black SpatterGuard™ Coated Titanium or Stainless Steel				

### TITANIUM SERIES PART NUMBERS

DC 3-wire 10-30 V PNP - Open	ECS1-0802P-ACL3-PTFE-120C-WFI-TC4	ECS1-0802P-ARU4-PTFE-120C-WFI-TC4	ECS1-1204P-ARU4-PTFE-120C-WFI-TC4	ECS1-1808P-ARU4-PTFE-120C-WFI-TC4	ECS1-3015P-ARU4-PTFE-120C-WFI-TC4
DC 3-wire 10-30 V PNP - Closed	ECS1-0802P-BCL3-PTFE-120C-WFI-TC4	ECS1-0802P-BRU4-PTFE-120C-WFI-TC4	ECS1-1204P-BRU4-PTFE-120C-WFI-TC4	ECS1-1808P-BRU4-PTFE-120C-WFI-TC4	ECS1-3015P-BRU4-PTFE-120C-WFI-TC4
DC 3-wire 10-30 V NPN - Open	ECS1-0802N-ACL3-PTFE-120C-WFI-TC4	ECS1-0802N-ARU4-PTFE-120C-WFI-TC4	ECS1-1204N-ARU4-PTFE-120C-WFI-TC4	ECS1-1808N-ARU4-PTFE-120C-WFI-TC4	ECS1-3015N-ARU4-PTFE-120C-WFI-TC4
DC 3-wire 10-30 V NPN - Closed	ECS1-0802N-BCL3-PTFE-120C-WFI-TC4	ECS1-0802N-BRU4-PTFE-120C-WFI-TC4	ECS1-1204N-BRU4-PTFE-120C-WFI-TC4	ECS1-1808N-BRU4-PTFE-120C-WFI-TC4	ECS1-3015N-BRU4-PTFE-120C-WFI-TC4

### STAINLESS SERIES PART NUMBERS

DC 3-wire 10-30 V PNP - Open	ECS1-0802P-ACL3-PTFE-120C-WFI	ECS1-0802P-ARU4-PTFE-120C-WFI	ECS1-1204P-ARU4-PTFE-120C-WFI	ECS1-1808P-ARU4-PTFE-120C-WFI	ECS1-3015P-ARU4-PTFE-120C-WFI
DC 3-wire 10-30 V PNP - Closed	ECS1-0802P-BCL3-PTFE-120C-WFI	ECS1-0802P-BRU4-PTFE-120C-WFI	ECS1-1204P-BRU4-PTFE-120C-WFI	ECS1-1808P-BRU4-PTFE-120C-WFI	ECS1-3015P-BRU4-PTFE-120C-WFI
DC 3-wire 10-30 V NPN - Open	ECS1-0802N-ACL3-PTFE-120C-WFI	ECS1-0802N-ARU4-PTFE-120C-WFI	ECS1-1204N-ARU4-PTFE-120C-WFI	ECS1-1808N-ARU4-PTFE-120C-WFI	ECS1-3015N-ARU4-PTFE-120C-WFI
DC 3-wire 10-30 V NPN - Closed	ECS1-0802N-BCL3-PTFE-120C-WFI	ECS1-0802N-BRU4-PTFE-120C-WFI	ECS1-1204N-BRU4-PTFE-120C-WFI	ECS1-1808N-BRU4-PTFE-120C-WFI	ECS1-3015N-BRU4-PTFE-120C-WFI

WELD FIELD IMMUNE METALHEAD™ SENSORS WITH BLACK SPATTERGUARD™ ARE THE BEST CHOICE FOR AUTOMATED WELD CELLS WHERE A MORE DURABLE SENSOR IS REQUIRED TO REDUCE DOWNTIME.





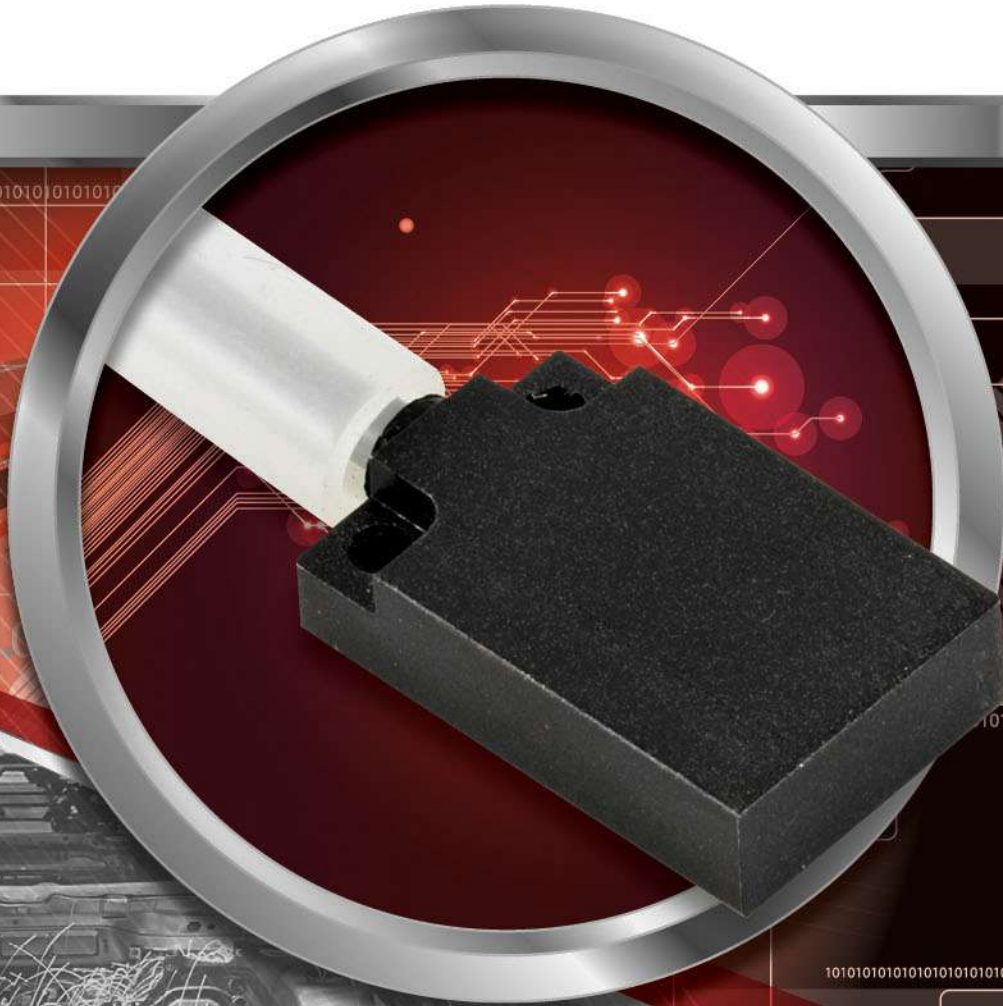
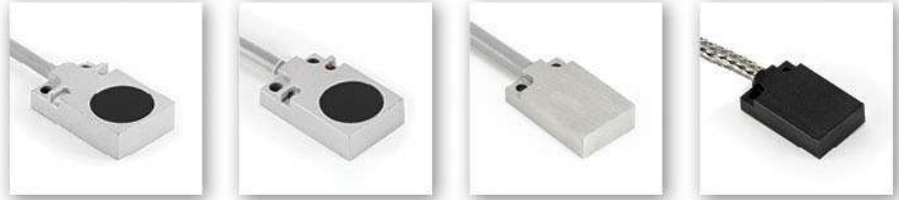
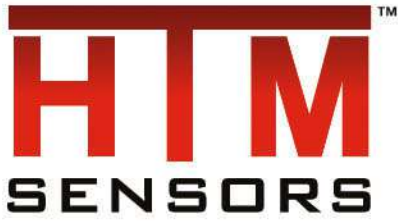

- FIXED MOUNT SENSORS FOR EASY MOUNTING
- RELIABLE SENSING DISTANCE
- NOW AVAILABLE IN METALHEAD™ VERSIONS
- AVAILABLE WITH METALBRAID OR PRE-INSTALLED SILICONE TUBING
- AVAILABLE WITH SPATTERGUARD™ COATING FOR WELDING AREAS
- AVAILABLE IN M8 OR M12 CONNECTORS OR PRE-WIRED





# METALHEAD™ FLATPACK SENSORS SPECIFICATIONS



Dimensions	20 mm x 32 mm x 8 mm				
Sensing Distance	8 mm				
Operating Voltage	10-30 VDC				
Operating Temperature	-25 °C - +100 °C				
Housing Material	PTFE Coated Brass Housing / PBT Sensing Face		1-Piece Stainless Steel Face and Body	1-Piece PTFE Coated Stainless Steel Face and Body	
Cable Jacket		Factory Pre-Installed High Temperature Silicone Jacket		Cut Resistant Braided Stainless Steel Cable Jacket	Factory Pre-Installed High Temperature Silicone Fiberglass Jacket
PNP - N/O - 0.3 m Pigtail M12	EQM1-2008P-A3U0.3/P12-PTFE-100C	EQM1-2008P-A3U0.3/P12-PTFE-100C-S	EQS1-2008P-A3U0.3/P12-100C	EQS1-2008P-A3U0.3/P12-PTFE-100C-HD	EQS1-2008P-A3U0.3/P12-PTFE-100C-WD
PNP - N/O - 0.7 m Pigtail M12	EQM1-2008P-A3U0.7/P12-PTFE-100C	EQM1-2008P-A3U0.7/P12-PTFE-100C-S	EQS1-2008P-A3U0.7/P12-100C	EQS1-2008P-A3U0.7/P12-PTFE-100C-HD	EQS1-2008P-A3U0.7/P12-PTFE-100C-WD
PNP - N/O - 0.3 m Pigtail M8	EQM1-2008P-A3U0.3/P8-PTFE-100C	EQM1-2008P-A3U0.3/P8-PTFE-100C-S	EQS1-2008P-A3U0.3/P8-100C	EQS1-2008P-A3U0.3/P8-PTFE-100C-HD	EQS1-2008P-A3U0.3/P8-PTFE-100C-WD
PNP - N/O - 0.7 m Pigtail M8	EQM1-2008P-A3U0.7/P8-PTFE-100C	EQM1-2008P-A3U0.7/P8-PTFE-100C-S	EQS1-2008P-A3U0.7/P8-100C	EQS1-2008P-A3U0.7/P8-PTFE-100C-HD	EQS1-2008P-A3U0.7/P8-PTFE-100C-WD
NPN - N/O - 0.3 m Pigtail M12	EQM1-2008N-A3U0.3/P12-PTFE-100C	EQM1-2008N-A3U0.3/P12-PTFE-100C-S	EQS1-2008N-A3U0.3/P12-100C	EQS1-2008N-A3U0.3/P12-PTFE-100C-HD	EQS1-2008N-A3U0.3/P12-PTFE-100C-WD
NPN - N/O - 0.7 m Pigtail M12	EQM1-2008N-A3U0.7/P12-PTFE-100C	EQM1-2008N-A3U0.7/P12-PTFE-100C-S	EQS1-2008N-A3U0.7/P12-100C	EQS1-2008N-A3U0.7/P12-PTFE-100C-HD	EQS1-2008N-A3U0.7/P12-PTFE-100C-WD
NPN - N/O - 0.3 m Pigtail M8	EQM1-2008N-A3U0.3/P8-PTFE-100C	EQM1-2008N-A3U0.3/P8-PTFE-100C-S	EQS1-2008N-A3U0.3/P8-100C	EQS1-2008N-A3U0.3/P8-PTFE-100C-HD	EQS1-2008N-A3U0.3/P8-PTFE-100C-WD
NPN - N/O - 0.7 m Pigtail M8	EQM1-2008N-A3U0.7/P8-PTFE-100C	EQM1-2008N-A3U0.7/P8-PTFE-100C-S	EQS1-2008N-A3U0.7/P8-100C	EQS1-2008N-A3U0.7/P8-PTFE-100C-HD	EQS1-2008N-A3U0.7/P8-PTFE-100C-WD

\*\*\*N/C versions available, change A to B in part #

\*\*\*Pre-wired versions available, change P8 or P12 to cable length, ie. 2 m, 5 m

\*\*\*AC and DC 2-wire models may be available

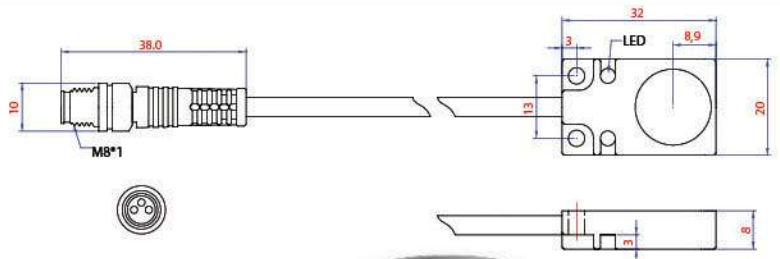

METALHEAD™ FLATPACK SENSORS OFFER A RELIABLE SENSING RANGE WITH EASY MOUNTING AND LONG LASTING PERFORMANCE WITH A STEEL FACE AND DURABLE CABLE OPTIONS.

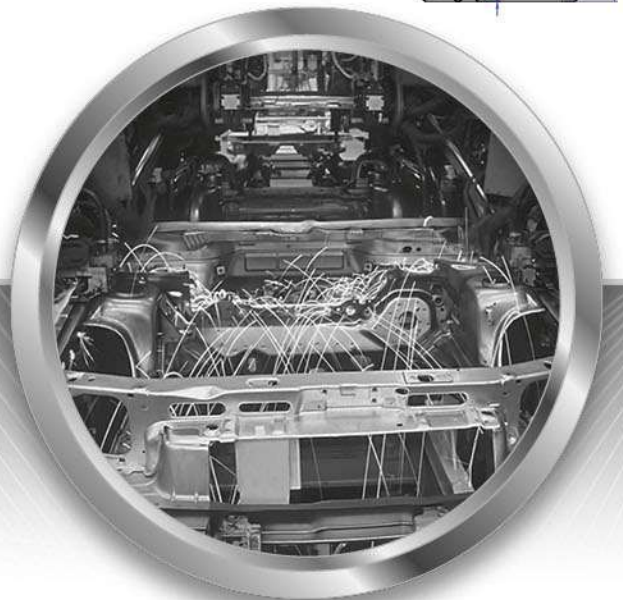



**HTM**<sup>TM</sup>  
**SENSORS**

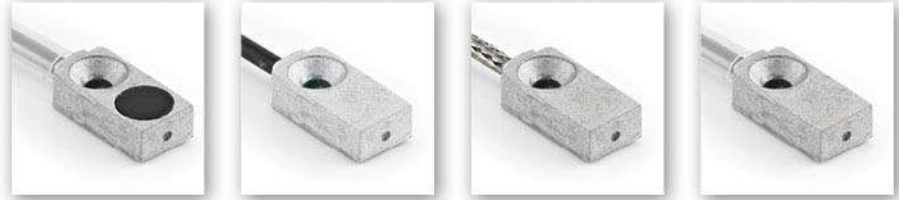

- FIXED MOUNT SENSORS FOR EASY MOUNTING
- RELIABLE SENSING DISTANCE
- NOW AVAILABLE IN METALHEAD™ VERSIONS
- AVAILABLE WITH METALBRAID OR PRE-INSTALLED SILICONE TUBING
- AVAILABLE WITH SPATTERGUARD™ COATING FOR WELDING AREAS
- AVAILABLE IN M8 OR M12 CONNECTORS OR PRE-WIRED





# METALHEAD™ FLATPACK SENSORS SPECIFICATIONS



Dimensions	8 mm x 17 mm x 4.7 mm				
Sensing Distance	2 mm				
Operating Voltage	10-30 VDC				
Operating Temperature	-25 °C - +100 °C				
Housing Material	PTFE Coated Brass Housing with Plastic Sensing Face		1-Piece Stainless Steel Body and Sensing Face		
Cable Material	Oil Resistant PUR Cable	Oil Resistant PUR Cable	Oil Resistant PUR Cable	Oil Resistant PUR Cable	Oil Resistant PUR Cable
Cable Jacket		Factory Pre-Installed High Temperature Silicone Jacket		Cut Resistant Braided Stainless Steel Cable Jacket	Factory Pre-Installed High Temperature Silicone Fiberglass Jacket
PNP - N/O - 0.3 m Pigtail M12	MQM1-8802P-A3U0.3/P12-PTFE-100C	MQM1-8802P-A3U0.3/P12-PTFE-100C-WD	MQS1-8802P-A3U0.3/P12-PTFE-100C	MQS1-8802P-A3U0.3/P12-PTFE-100C-HD	MQS1-8802P-A3U0.3/P12-PTFE-100C-WD
PNP - N/O - 0.7 m Pigtail M12	MQM1-8802P-A3U0.7/P12-PTFE-100C	MQM1-8802P-A3U0.7/P12-PTFE-100C-WD	MQS1-8802P-A3U0.7/P12-PTFE-100C	MQS1-8802P-A3U0.7/P12-PTFE-100C-HD	MQS1-8802P-A3U0.7/P12-PTFE-100C-WD
PNP - N/O - 0.3 m Pigtail M8	MQM1-8802P-A3U0.3/P8-PTFE-100C	MQM1-8802P-A3U0.3/P8-PTFE-100C-WD	MQS1-8802P-A3U0.3/P8-PTFE-100C	MQS1-8802P-A3U0.3/P8-PTFE-100C-HD	MQS1-8802P-A3U0.3/P8-PTFE-100C-WD
PNP - N/O - 0.7 m Pigtail M8	MQM1-8802P-A3U0.7/P8-PTFE-100C	MQM1-8802P-A3U0.7/P8-PTFE-100C-WD	MQS1-8802P-A3U0.7/P8-PTFE-100C	MQS1-8802P-A3U0.7/P8-PTFE-100C-HD	MQS1-8802P-A3U0.7/P8-PTFE-100C-WD
NPN - N/O - 0.3 m Pigtail M12	MQM1-8802N-A3U0.3/P12-PTFE-100C	MQM1-8802N-A3U0.3/P12-PTFE-100C-WD	MQS1-8802N-A3U0.3/P12-PTFE-100C	MQS1-8802N-A3U0.3/P12-PTFE-100C-HD	MQS1-8802N-A3U0.3/P12-PTFE-100C-WD
NPN - N/O - 0.7 m Pigtail M12	MQM1-8802N-A3U0.7/P12-PTFE-100C	MQM1-8802N-A3U0.7/P12-PTFE-100C-WD	MQS1-8802N-A3U0.7/P12-PTFE-100C	MQS1-8802N-A3U0.7/P12-PTFE-100C-HD	MQS1-8802N-A3U0.7/P12-PTFE-100C-WD
NPN - N/O - 0.3 m Pigtail M8	MQM1-8802N-A3U0.3/P8-PTFE-100C	MQM1-8802N-A3U0.3/P8-PTFE-100C-WD	MQS1-8802N-A3U0.3/P8-PTFE-100C	MQS1-8802N-A3U0.3/P8-PTFE-100C-HD	MQS1-8802N-A3U0.3/P8-PTFE-100C-WD
NPN - N/O - 0.7 m Pigtail M8	MQM1-8802N-A3U0.7/P8-PTFE-100C	MQM1-8802N-A3U0.7/P8-PTFE-100C-WD	MQS1-8802N-A3U0.7/P8-PTFE-100C	MQS1-8802N-A3U0.7/P8-PTFE-100C-HD	MQS1-8802N-A3U0.7/P8-PTFE-100C-WD

\*\*\* N/C versions available, change A to B in part #

\*\*\* Pre-Wired versions available, change P8 to cable length, ie. 2 m, 5 m

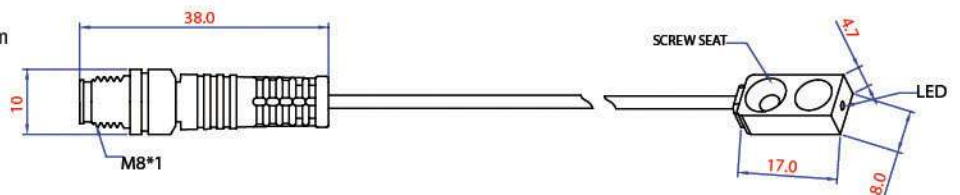

METALHEAD™ FLATPACK SENSORS OFFER A RELIABLE SENSING RANGE WITH EASY MOUNTING AND LONG LASTING PERFORMANCE WITH A STEEL FACE AND DURABLE CABLE OPTIONS.

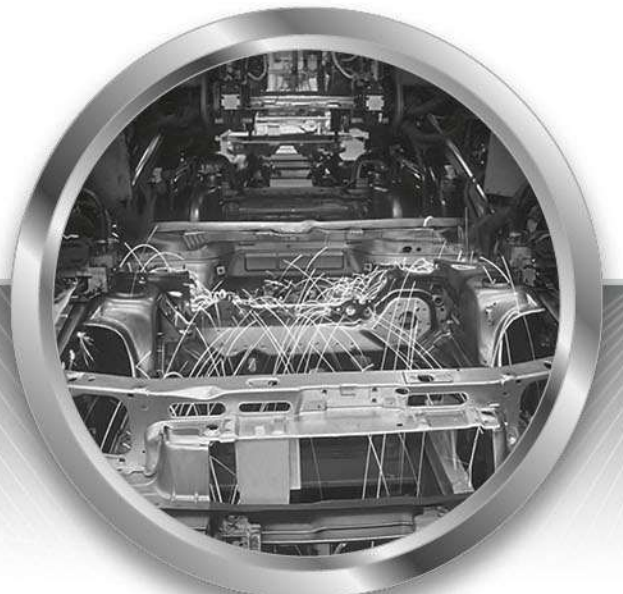



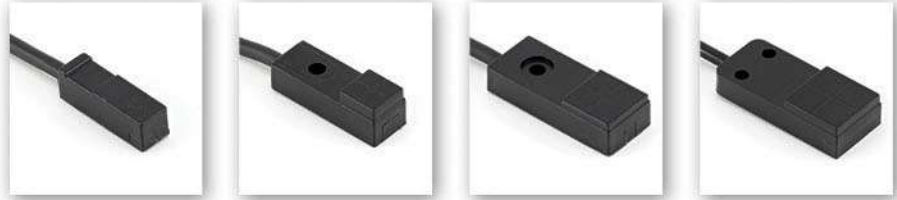
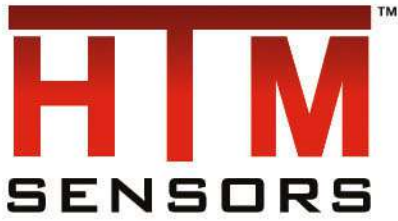

- MINIATURE PROXIMITY SENSORS FOR TIGHT MOUNTING SPACES
- IDEAL FOR USE IN STAMPING DIES FOR IN-DIE SENSING
- MOUNTING HOLE PROVIDES EASY INSTALLATION
- FIXED MOUNT SENSORS OFFER REPEATABLE INSTALLATION DISTANCE
- 5 m CABLE OR PIGTAIL CONNECTOR VERSIONS AVAILABLE FROM STOCK
- AVAILABLE IN PNP, NPN AND DC 2-WIRE OUTPUT FUNCTIONS





# MINI FIXED-MOUNT SENSORS SPECIFICATIONS

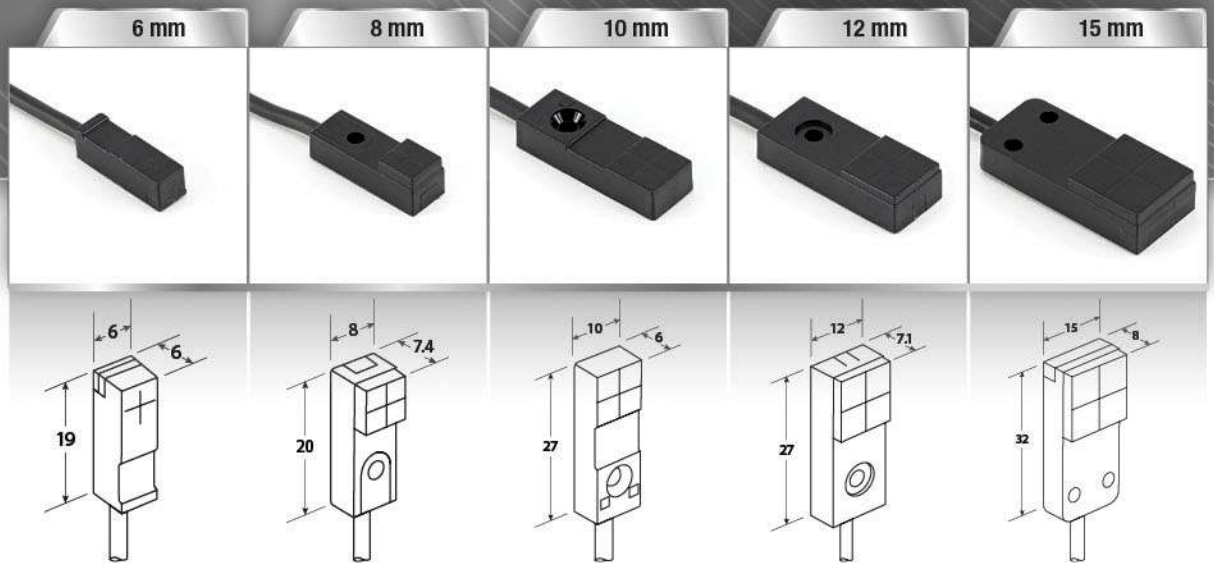

DIMENSIONS (mm)	6 W x 6 H x 19 L	8 W x 7.4 H x 20 L	10 W x 6 H x 27 L	12 W x 7.1 H x 27 L	15 W x 8 H x 32 L
SENSING DISTANCE	1.5 mm	2.5 mm	2 mm	2 mm	4 mm
<b>PART NUMBERS</b>					
DC 3-wire 10-30 V PNP - Open	MQP2-661.2P-A3L5F	MQP2-882.5P-A3L5F	MQP2-1002P-A3L5F	MQP2-1202P-A3L5F	MQP2-1504P-A3L5F
DC 3-wire 10-30 V PNP - Closed	MQP2-661.2P-B3L5F	MQP2-882.5P-B3L5F	MQP2-1002P-B3L5F	MQP2-1202P-B3L5F	MQP2-1504P-B3L5F
DC 3-wire 10-30 V NPN - Open	MQP2-661.2N-A3L5F	MQP2-882.5N-A3L5F	MQP2-1002N-A3L5F	MQP2-1202N-A3L5F	MQP2-1504N-A3L5F
DC 3-wire 10-30 V NPN - Closed	MQP2-661.2N-B3L5F	MQP2-882.5N-B3L5F	MQP2-1002N-B3L5F	MQP2-1202N-B3L5F	MQP2-1504N-B3L5F
DC 2-wire 10-30 V - Open	MQP2-661.2C-A3L5F	MQP2-882.5C-A3L5F	MQP2-1002C-A3L5F	MQP2-1202C-A3L5F	MQP2-1504C-A3L5F
DC 2-wire 10-30 V - Closed	MQP2-661.2C-B3L5F	MQP2-882.5C-B3L5F	MQP2-1002C-B3L5F	MQP2-1202C-B3L5F	MQP2-1504C-B3L5F

MINI FIXED-MOUNT SENSORS ARE IDEAL FOR TIGHT SPACES AND FOR APPLICATIONS THAT REQUIRE A REPEATABLE MOUNTING PLACEMENT.





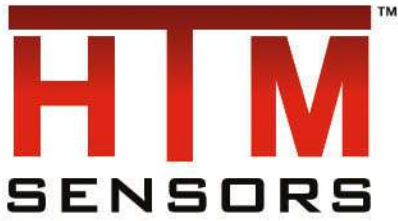

- MINIATURE SENSORS FOR SENSING METAL OBJECTS IN SMALL SPACES
- IDEAL FOR APPLICATIONS WHERE THE PART PLACEMENT IS REPEATABLE AND TIGHT IN TOLERANCE
- IDEAL FOR APPLICATIONS WHERE A SMALL SENSING DISTANCE IS REQUIRED FOR RELIABLE DETECTION
- AVAILABLE IN ANY PRE-WIRED CABLE LENGTH OR PIGTAILED CABLE LENGTH
- AVAILABLE IN M8 QUICK-CONNECT FOR EASY INSTALLATION
- MOST MODELS AVAILABLE IN EXTENDED RANGE OR LONG RANGE VERSIONS





# MINIATURE INDUCTIVE PROXIMITY SENSORS SPECIFICATIONS



SENSING DISTANCE	0.8 mm	0.8 mm	1 mm	1 mm	1 mm
OPERATING VOLTAGE	10-30 VDC				
OPERATING TEMPERATURE	-25 °C - +70 °C				
HOUSING MATERIAL	Stainless Steel / PBT Sensing Face				

## PART NUMBERS - 2 m CABLE VERSION

DC 3-wire PNP - NO	FCU1-D0301P-A3U2	FCU1-D0401P-A3U2	FCU1-0401P-A3U2	FCU1-0501P-A3U2	FCU1-D0601P-A3U2
DC 3-wire PNP - NC	FCU1-D0301P-B3U2	FCU1-D0401P-B3U2	FCU1-0401P-B3U2	FCU1-0501P-B3U2	FCU1-D0601P-B3U2
DC 3-wire NPN - NO	FCU1-D0301N-A3U2	FCU1-D0401N-A3U2	FCU1-0401N-A3U2	FCU1-0501N-A3U2	FCU1-D0601N-A3U2
DC 3-wire NPN - NC	FCU1-D0301N-B3U2	FCU1-D0401N-B3U2	FCU1-0401N-B3U2	FCU1-0501N-B3U2	FCU1-D0601N-B3U2

## 0.3 m Cable to M8 3-Pin Connector

DC 3-wire PNP - NO	FCU1-D0301P-A3U0.3/P8	FCU1-D0401P-A3U0.3/P8	FCU1-0401P-A3U0.3/P8	FCU1-0501P-A3U0.3/P8	FCU1-D0601P-A3U0.3/P8
DC 3-wire PNP - NC	FCU1-D0301P-B3U0.3/P8	FCU1-D0401P-B3U0.3/P8	FCU1-0401P-B3U0.3/P8	FCU1-0501P-B3U0.3/P8	FCU1-D0601P-B3U0.3/P8
DC 3-wire NPN - NO	FCU1-D0301N-A3U0.3/P8	FCU1-D0401N-A3U0.3/P8	FCU1-0401N-A3U0.3/P8	FCU1-0501N-A3U0.3/P8	FCU1-D0601N-A3U0.3/P8
DC 3-wire NPN - NC	FCU1-D0301N-B3U0.3/P8	FCU1-D0401N-B3U0.3/P8	FCU1-0401N-B3U0.3/P8	FCU1-0501N-B3U0.3/P8	FCU1-D0601N-B3U0.3/P8

MINIATURE INDUCTIVE PROXIMITY SENSORS ARE PERFECT FOR TIGHT SPACES AND FOR MACHINES THAT REQUIRE A TIGHT SENSING TOLERANCE TO DETECT OBJECTS.





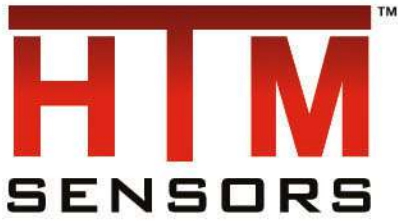

- RING SENSORS FOR METAL PARTS DETECTION
- 4 SIZES AVAILABLE FROM 10 mm TO 43 mm
- CONVENIENT SIDE SCREW MOUNTING
- IDEAL FOR WELD WIRE DETECTION, OR SMALL PARTS DETECTION
- AVAILABLE IN AC OR DC, NPN OR PNP OUTPUTS WITH OR WITHOUT TIMING FUNCTION
- AVAILABLE IN M12 QUICK-CONNECT OR PRE-WIRED VERSIONS





# INDUCTIVE RING PROXIMITY SENSORS SPECIFICATIONS



Min. Target Size	D=3 mm; L=6 mm	D=9 mm; L=18 mm	D=6 mm; L=12 mm	D=9 mm; L=18 mm
<b>PART NUMBERS</b>				
DC 3-wire 10-30 V NPN N.O.	RRP2-R1020N-ARU4	RRP2-R1520N-ARU4	RRP2-R2120N-ARU4	RRP2-R4320N-ARU4
DC 3-wire 10-30 V NPN N.C.	RRP2-R1020N-BRU4	RRP2-R1520N-BRU4	RRP2-R2120N-BRU4	RRP2-R4320N-BRU4
DC 3-wire 10-30 V PNP N.O.	RRP2-R1020P-ARU4	RRP2-R1520P-ARU4	RRP2-R2120P-ARU4	RRP2-R4320P-ARU4
DC 3-wire 10-30 V PNP N.C.	RRP2-R1020P-BRU4	RRP2-R1520P-BRU4	RRP2-R2120P-BRU4	RRP2-R4320P-BRU4
AC 2-wire 20-250 V N.O.	RRP2-R1020A-AUL3	RRP2-R1520A-AUL3	RRP2-R2120A-AUL3	RRP2-R4320A-AUL3
AC 2-wire 20-250 V N.C.	RRP2-R1020A-BUL3	RRP2-R1520A-BUL3	RRP2-R2120A-BUL3	RRP2-R4320A-BUL3

INDUCTIVE RING SENSORS OFFER THE RELIABLE SENSING OF METAL PARTS, WIRES, AND OBJECTS, WHERE THE PARTS ARE MOVING THROUGH AN AREA AND NEED TO BE DETECTED.





**HTM**<sup>TM</sup>  
**SENSORS**



- CAPACITIVE SENSORS FOR LEVEL CONTROL AND NON-METALLIC PRESENCE DETECTION
- AVAILABLE IN PLASTIC OR STAINLESS STEEL HOUSINGS
- AVAILABLE WITH A PRE-WIRED CABLE OF ANY LENGTH, OR WITH A QUICK-CONNECT
- AVAILABLE WITH PNP, NPN, AC AND AC/DC OUTPUT FUNCTIONS
- AVAILABLE IN SHIELDED OR UNSHIELDED CONSTRUCTION FOR ANY APPLICATION
- IDEAL FOR USE IN MACHINES THAT REQUIRE NON-METALLIC, NON-CONTACT SENSING



# CAPACITIVE PROXIMITY SENSORS SPECIFICATIONS



SENSING DISTANCE	1-15 mm adjustable	1-15 mm adjustable	1-30 mm adjustable	1-30 mm adjustable	1-40 mm adjustable
OPERATING TEMPERATURE	-25 °C - +70 °C				
SENSING FACE MATERIAL	PBT Plastic	PTFE	PBT Plastic	PTFE	PTFE
HOUSING MATERIAL	PBT Plastic	Stainless Steel	PBT Plastic	Stainless Steel	Stainless Steel
PART NUMBERS					
DC 3-wire 10-30 V PNP - Open	CCP2-1815P-A3U2	CCU2-1815P-A3U2	CCP2-3030P-A3U2	CCU2-3030P-A3U2	CCU2-3240P-A3U2
DC 3-wire 10-30 V PNP - Closed	CCP2-1815P-B3U2	CCU2-1815P-B3U2	CCP2-3030P-B3U2	CCU2-3030P-B3U2	CCU2-3240P-B3U2
DC 3-wire 10-30 V NPN - Open	CCP2-1815N-A3U2	CCU2-1815N-A3U2	CCP2-3030N-A3U2	CCU2-3030N-A3U2	CCU2-3240N-A3U2
DC 3-wire 10-30 V NPN - Closed	CCP2-1815N-B3U2	CCU2-1815N-B3U2	CCP2-3030N-B3U2	CCU2-3030N-B3U2	CCU2-3240N-B3U2
AC 110-220 VAC - Open	CCP2-1815A-A3U2	CCU2-1815A-A3U2	CCP2-3030A-A3U2	CCU2-3030A-A3U2	CCU2-3240A-A3U2
AC 110-220 VAC - Closed	CCP2-1815A-B3U2	CCU2-1815A-B3U2	CCP2-3030A-B3U2	CCU2-3030A-B3U2	CCU2-3240A-B3U2

\*Flatpack, M6.5, M8 and M12 sizes available.

CAPACITIVE SENSORS ARE THE BEST CHOICE FOR THE RELIABLE DETECTION OF LIQUIDS, BULK SOLIDS, PLASTICS, POWDERS, PELLETS AND PASTES WHERE A NON-CONTACT SOLUTION IS REQUIRED.





**HTM**<sup>TM</sup>  
**SENSORS**



- M18 PHOTOELECTRIC SENSORS FOR EASY MOUNTING
- DURABLE METAL HOUSING FOR ALL APPLICATIONS
- QUICK-CONNECT FOR EASY INSTALLATION
- AVAILABLE IN PNP, NPN AND AC MODELS
- AVAILABLE IN DIFFUSE, RETROREFLECTIVE AND THRU-BEAM
- NEW: AVAILABLE LASER MODELS



# M18 PHOTOELECTRIC SENSORS SPECIFICATIONS

**DIFFUSE**



**POLARIZED REFLECTIVE**



**THRU-BEAM**



**BACKGROUND SUPPRESSION**



**LASER DIFFUSE**



Sensing Distance	500 mm	1 m	15 m	100 mm	350 mm
Light Emission	Infrared LED (880 nm)	RED LED (660 nm)	Infrared LED (880 n)	RED LED (680 nm)	Red Laser: Class 1 - EN 60825-1
Power Supply	10-30 V DC / 20-250 V AC Models			10-30 V DC	
Current Consumption	30 mA Max. / 5 mA Max AC Models			35 mA Max.	
Max. Current Load	200 mA / 300 mA AC Models			100 mA Max.	
Voltage Drop	2.5 V Max. / 10 V AC Models			2 V Max.	
Response Time	1.5 ms			1 ms	333 microseconds
Housing Material	Nickel-Plated Brass / Stainless Steel Available - PMMA or PBT Lens				
Mechanical Protection	IP67				
<b>Quick Connect (Dimensions)</b>	M18 x 75 mm	M18 x 75 mm	M18 x 75 mm	M18 x 71.5 mm	M18 x 71.5 mm
DC Emitter			M18B-T015MD-EX9Q4LE		
PNP - Light On/Dark On	M18B-D0500P-CX9Q4UE	M18B-L1000P-CX9Q4UE-PF	M18B-T015MP-CX9Q4UE	M18B-D0100P-CX6Q4UE-BS	M18B-D0350P-CX8Q4UE-LSR
NPN - Light On/Dark On	M18B-D0500N-CX9Q4UE	M18B-L1000N-CX9Q4UE-PF	M18B-T015MN-CX9Q4UE	M18B-D0100N-CX6Q4UE-BS	M18B-D0350N-CX8Q4UE-LSR
AC Emitter			M18B-T015MA-EX9Q4LM		
AC - Light On	M18B-D0500A-LX9Q4UM	M18B-L1000A-LX9Q4UM-PF	M18B-T015MP-CX9Q4UE		
AC - Dark On	M18B-D0500P-DX9Q4UM	M18B-L1000A-DX9Q4UM-PF	M18B-T015MP-CX9Q4UE		
<b>PreWired Cable (Dimensions)</b>	M18 x 64 mm	M18 x 64 mm	M18 x 64 mm	M18 x 57 mm	M18 x 57 mm
DC Emitter			M18B-T015MD-EX9C4U2		
PNP - Light On/Dark On	M18B-D0500P-CX9C4U2	M18B-L1000P-CX9C4U2-PF	M18B-T015MP-CX9C4U2	M18B-D0100P-CX9C4U2-BS	M18B-D0350P-CX8C4U2-LSR
NPN - Light On/Dark On	M18B-D0500N-CX9C4U2	M18B-L1000N-CX9C4U2-PF	M18B-T015MN-CX9C4U2	M18B-D0100N-CX9C4U2-BS	M18B-D0350N-CX8C4U2-LSR
AC Emitter			M18B-T015MA-EX9C3U2		
AC - Light On	M18B-D0500A-LX9C3U2	M18B-L1000A-LX9C3U2-PF	M18B-T015MP-CX9C3U2		
AC - Dark On	M18B-D0500P-DX9C3U2	M18B-L1000A-DX9C3U2-PF	M18B-T015MP-CX9C3U2		

M18 PHOTOELECTRICS ARE A VERSATILE AND ECONOMICAL STYLE FOR MANY SENSING APPLICATIONS. THE METAL HOUSING IS DURABLE AND THE STANDARD M18 SIZE IS EASY TO MOUNT FOR A QUICK INSTALLATION AND RELIABLE OPERATION.





IP69K STAINLESS STEEL  
PHOTOELECTRIC SENSORS

**HTM**<sup>TM</sup>  
**SENSORS**



- DURABLE STAINLESS STEEL IP69K PHOTOELECTRIC SENSOR
- IP69K FOR WASHDOWN AREAS, AND AROUND CHEMICALS AND OIL
- RUGGED HOUSING FOR AUTOMOTIVE APPLICATIONS
- HIGH QUALITY CONSTRUCTION AND PERFORMANCE
- AVAILABLE IN CLEAR OBJECT AND LASER BGS
- AVAILABLE IN BGS, RETROREFLECTIVE AND THRU-BEAM



# IP69K STAINLESS STEEL PHOTOELECTRIC SENSORS SPECIFICATIONS

## CLEAR OBJECT DIFFUSE



## POLARIZED REFLECTIVE



## THRU-BEAM



## BACKGROUND SUPPRESSION



## LASER BACKGROUND SUPPRESSION



Sensing Distance	300 mm	5 m	25 m	50 - 300 mm	20 - 200 mm
Setting	Pushbutton Teach	Adjustment Trimmer	Adjustment Trimmer	Adjustment Trimmer	Adjustment Trimmer
Light Emission	Red LED (660 nm)	RED LED (660 nm)	RED LED (660 nm)	RED LED (660 nm)	Red Laser: Class 2-EN 60825-1
Power Supply	12-30 VDC				
Current Consumption	35 mA	35 mA	15 mA Max. Emitter, 20 mA Max. Receiver	35 mA	35 mA Max.
Max. Current Load	100 mA (overload protection)				
Voltage Drop	< 2 V				
Response Time	500 $\mu$ s	500 $\mu$ s	500 $\mu$ s	1 ms	333 microseconds
Switching Frequency	1 kHz	1 kHz	1 kHz	500 Hz	5 kHz
Housing Material	Stainless Steel / PC Lens				
Mechanical Protection	IP69K				
Operating Temperature	-10 °C - +55 °C				
Vibration	0.5 mm amplitude, 10-55 Hz frequency per axis (EN60068-2-6)				
Shock Resistance	11 ms (30 G) 6 shocks per axis (EN60068-2-27)				
Connection	M8 4-pin Quick-Connect				
DC Emitter			H80-TBPS-E25P-M08-4QD		
PNP - Light On/Dark On	H80-C0DS-0300P-M08-4QD	H80-PRRS-5000P-M08-4QD	H80-TBPS-R25P-M08-4QD	H80-BGSS-0300P-M08-4QD	H80-LBGS-0200P-M08-4QD
NPN - Light On/Dark On	H80-C0DS-0300N-M08-4QD	H80-PRRS-5000N-M08-4QD	H80-TBPS-R25N-M08-4QD	H80-BGSS-0300N-M08-4QD	H80-LBGS-0200N-M08-4QD



HIGH PERFORMANCE PHOTOELECTRIC SENSORS MADE OF STAINLESS STEEL AND CONFORM TO IP69K ARE IDEAL FOR APPLICATIONS WHERE A RUGGED AND SEALED UNIT IS REQUIRED FOR RELIABLE AND LONG-LASTING SENSING.

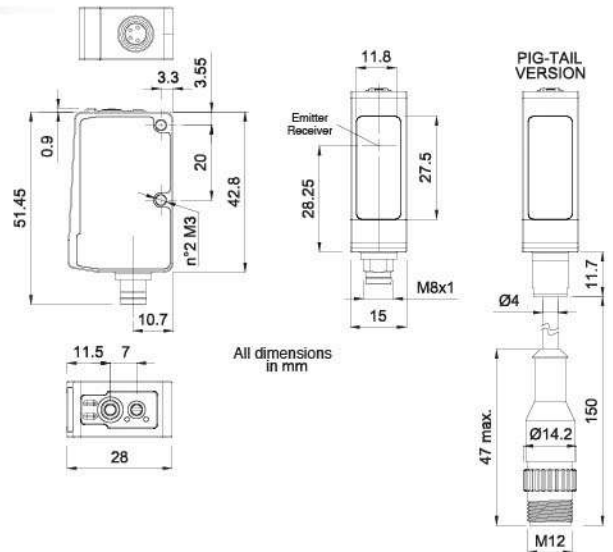



**HTM**<sup>TM</sup>  
**SENSORS**



- LONG RANGE PHOTOELECTRIC SENSORS
- RUGGED DESIGN FOR MANY APPLICATIONS
- BUILT-IN TIMERS AND DELAYS FOR RELIABLE OUTPUTS
- AVAILABLE IN PNP, NPN, AND AC MODELS
- AVAILABLE WITH DC OR AC QUICK-CONNECT OR PRE-WIRED MODELS
- AVAILABLE IN LONG RANGE DIFFUSE, RETROREFLECTIVE OR THRU-BEAM



# RP74 PHOTOELECTRIC SENSORS SPECIFICATIONS

**THRU-BEAM**

**DIFFUSE**

**RETROREFLECTIVE**

**FIBER OPTIC**

**CLEAR OBJECT  
DETECTION**



Operating Range	61 m (200 ft.)	3.04 m (10 ft.)	9.14 m (30 ft.)	Depends on fiber	1.20 m (3.9 ft.)
Light Emission	Infrared LED (880 nm)	Infrared LED (880 nm)	RED LED (660 nm)	Infrared LED (880 nm)	RED LED (660 nm)
Power Supply	10-40 VDC or 12-240 VDC/24-240 VAC				
Current Consumption	35 mA Max.				
Indicator LEDs	Green: Power, Yellow: Output, Red: Margin				
Saturation Voltage	2.5 V Max.				
Output Current	DC Models 250 mA / Relay Models 10 A at 120 VAC / 5 A at 240 VAC				
Response Time	NPN/PNP: 5 ms, SPDT Relay: 23 ms				
Timing Options	No Delay, On Delay, Off Delay, One-shot (for Models with Timing Delay)				
Time Settings	Adjustable, 0.1...15 s (for Models with Timing Delay)				
Mechanical Protection	IP67				
Housing Material	Glass Fiber Reinforced Plastic, Cover Gasket Material: Neoprene				
Lens Material	Acrylic				
Operating Temperature	-25...+55 °C (-13...+131 °F)				
Storage Temperature	-40...+55 °C (-40...+131 °F)				
Reference Standard	EN 60947-5-2				

**DC Models** (10-40 VDC) M12 - Recommended Mating Cable: part # R-FS4TZ-V075 (straight), R-FA4TZ-V075 (right angle)

Emitter	RP74-T061MD-EY9Q4LE				
NPN / PNP - with timing	RP74-T061MD-CY9Q4UE-T	RP74-D3040D-CY9Q4UE-T	RP74-L9140D-CY6Q4UE-T	RP74-FGFD-CY9Q4UE-T	RP74-S1200D-CY6Q4UE-T

**AC Models** (12-240 VDC/24-240 VAC) ½"-20 UNF - Recommended Mating Cable: part # U-FS5TA-V105 (straight), U-FA5TA-V105 (right-angle) AC Emitter - U-FS4TAV105 (straight), U-FA4TAV105 (right angle)

Emitter	RP74-T061MA-EY9Q4LM				
SPDT Relay - with timing	RP74-T061MR-CY9Q5LM-T	RP74-D3040R-CY9Q5LM-T	RP74-L9140R-CY6Q5LM-T	RP74-FGFR-CY9Q5LM-T	RP74-S1200R-CY6Q5LM-T

Emitter AC

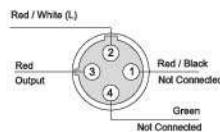
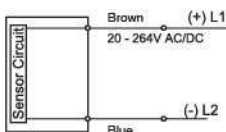

AC Receiver, Diffuse & Retro

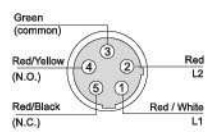
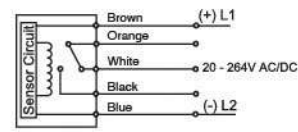

Emitter DC

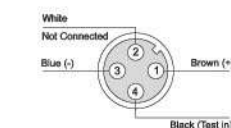
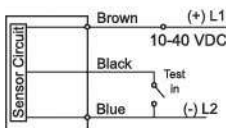

NPN / PNP

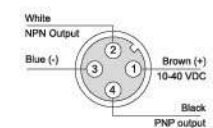
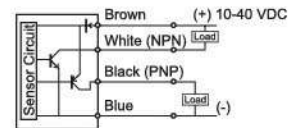

LONG RANGE PHOTOELECTRIC SENSORS ARE IDEAL FOR SENSING OVER LONG DISTANCES, AND COME WITH A RUGGED HOUSING FOR A VARIETY OF APPLICATIONS.

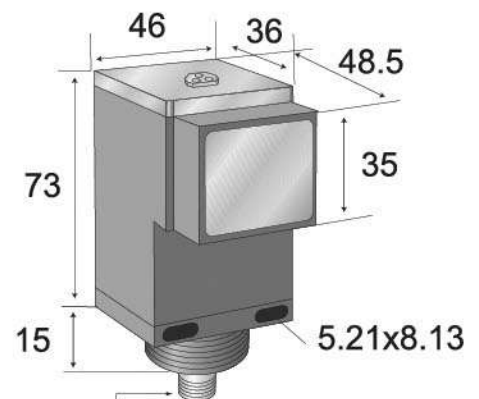

AC: ½" - 20 UNF Thread  
DC: M12 x 1



**HTM**<sup>TM</sup>  
**SENSORS**

HAND PROTECTION  
30 mm / 1/18 in. RESOLUTION



- CATEGORY 4 SAFETY LIGHT CURTAINS
- RUGGED C-CHANNEL ALUMINUM HOUSING WITH ROTATING BRACKETS
- AVAILABLE FROM 6" TO 70" PROTECTIVE HEIGHT
- FAST RESPONSE TIMES, AND LONG 19 m OPERATING DISTANCE
- AVAILABLE WITH MIRRORS, AND IP69 ENCLOSURES
- DIGITAL DISPLAY FOR DIAGNOSTICS AND EASY ALIGNMENT



SAFETY LIGHT CURTAINS - CATEGORY 4  
HAND PROTECTION SPECIFICATIONS



CV-A1-20-B03 / B10



CABLES (3 m / 10 m)

CSME-03VU24-Y14



RELAY

HSC4-30



LIGHT CURTAINS

MODEL	BEAMS	RESPONSE TIME	PROTECTIVE HEIGHT	TOTAL HEIGHT
HSC4-30-06	8	9 ms	150 mm (5.91 in.)	233.3 mm
HSC4-30-12	16	11 ms	300 mm (11.81 in.)	383.2 mm
HSC4-30-18	24	13 ms	450 mm (17.72 in.)	533.2 mm
HSC4-30-24	32	15 ms	600 mm (23.62 in.)	683.2 mm
HSC4-30-30	40	16 ms	750 mm (29.53 in.)	833.2 mm
HSC4-30-36	48	18 ms	900 mm (35.43 in.)	983.2 mm
HSC4-30-42	56	19 ms	1050 mm (41.34 in.)	1133.2 mm
HSC4-30-48	64	21 ms	1200 mm (47.24 in.)	1283.3 mm
HSC4-30-54	72	23 ms	1350 mm (53.15 in.)	1433.2 mm
HSC4-30-60	80	25 ms	1500 mm (59.06 in.)	1583.3 mm
HSC4-30-65	88	26 ms	1650 mm (64.96 in.)	1733.3 mm
HSC4-30-70	96	28 ms	1800 mm (70.87 in.)	1883.3 mm

CATEGORY 4 SAFETY LIGHT CURTAINS ARE IDEAL FOR PROTECTING PEOPLE FROM DANGEROUS MACHINERY WHERE HARD GUARDS ARE NOT PRACTICAL.









## QUICK-CONNECT SENSOR CABLES - M8 SPECIFICATIONS



Connection	M8 PVC		M8 PUR		M8 TPE	
	Straight	Angled	Straight	Angled	Straight	Angled
Cable Material	Low-Cost PVC		Oil-Resistant PUR		Weld Spatter Resistant TPE	
Wire Gauge	22 AWG					
Threaded Connector	Nickel-plated Brass				PTFE Coated Brass	
Nominal Voltage	250 VAC/300 VDC (10-30 VDC LED models)					
Protection	IP67					
3-pin / 3-wire	C-FS3TZ-V075	C-FA3TZ-V075	C-FS3TZ-Y075	C-FA3TZ-Y075	C-FS3TZ-T075	C-FA3TZ-T075
3-pin / 3-wire - PNP LED		C-FA3TP-V075	C-FA3TP-Y075		C-FA3TP-T075	R-FA4/3TP-T075
3-pin / 3-wire - NPN LED		C-FA3TN-V075	C-FA3TN-Y075		C-FA3TN-T075	R-FA4/3TN-T075
4-pin / 4-wire	C-FS4TZ-V075	C-FA4TZ-V075	C-FS4TZ-Y075	C-FA4TZ-Y075	C-FS4TZ-T075	C-FA4TZ-T075
For Food Grade Stainless Steel Nuts	Add -SS on the end of the part #					
For Weld Grade PTFE Coated Nuts	Add -PTFE on the end of the part #					
For 18AWG wires	Add -18AWG on the end of the part #					
For Factory Pre-Installed Silicone Sleeve	Add -S on the end of the part #					
For custom lengths	Change "5" on the end of the part # to the desired length in meters					
For male connectors	Change "F" in the part # to "M"					
For custom colors	Add -Black, -Grey, -Yellow, or -Orange to the end of the part #					

QUICK-CONNECT SENSOR CABLES HAVE A LOW PRICE,  
AND THOUSANDS IN STOCK FOR SAME DAY SHIPPING.





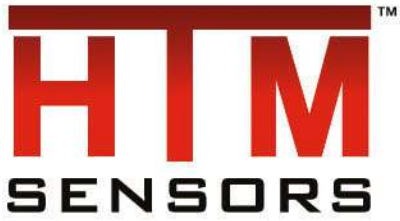

- QUICK-CONNECT SENSOR CABLES FOR SENSOR CONNECTIONS
- LOW PRICES WITH THOUSANDS IN STOCK FOR SAME-DAY SHIPPING
- AVAILABLE IN LOW-COST PVC, OIL-RESISTANT PUR, AND SPATTER-RESISTANT TPE
- AVAILABLE IN YELLOW, BLACK OR GREY OR CUSTOM COLORS
- AVAILABLE IN STANDARD 5 m LENGTH, OR ANY CUSTOM LENGTH
- ANY STYLE AVAILABLE WITH PRE-INSTALLED PROTECTIVE SILICONE JACKET



## QUICK-CONNECT SENSOR CABLES - M12 SPECIFICATIONS



Connection	M12 PVC		M12 PUR		M12 TPE	
	Female Straight	Female Angled	Female Straight	Female Angled	Female Straight	Female Angled
Cable Material	Low-Cost PVC		Oil-Resistant PUR		Weld Spatter Resistant TPE	
Wire Gauge	22 AWG					
Threaded Connector	Nickel-plated Brass				PTFE Coated Brass	
Nominal Voltage	250 VAC/300 VDC (10-30 VDC LED models)					
Protection	IP68					
4-pin / 4-wire	R-FS4TZ-V075	R-FA4TZ-V075	R-FS4TZ-Y075	R-FA4TZ-Y075	R-FS4TZ-T075	R-FA4TZ-T075
4-pin / 3-wire - PNP LED	R-FS4/3TP-V075	R-FA4/3TP-V075	R-FS4/3TP-Y075	R-FA4/3TP-Y075	R-FS4/3TP-T075	R-FA4/3TP-T075
4-pin / 3-wire - NPN LED	R-FS4/3TN-V075	R-FA4/3TN-V075	R-FS4/3TN-Y075	R-FA4/3TN-Y075	R-FS4/3TN-T075	R-FA4/3TN-T075
5-pin / 5-wire	R-FS5TZ-V075	R-FA5TZ-V075	R-FS5TZ-Y075	R-FA5TZ-Y075	R-FS5TZ-T075	R-FA5TZ-T075
8-pin / 8-wire	R-FS8TZ-V075	R-FA8TZ-V075	R-FS8TZ-Y075	R-FA8TZ-Y075	R-FS8TZ-T075	R-FA8TZ-T075
For Food Grade Stainless Steel Nuts	Add -SS on the end of the part #					
For Weld Grade PTFE Coated Nuts	Add -PTFE on the end of the part #					
For 18AWG wires	Add -18AWG on the end of the part #					
For Factory Pre-Installed Silicone Sleeve	Add - S on the end of the part #					
For custom lengths	Change "5" on the end of the part # to the desired length in meters					
For male connectors	Change "F" in the part # to "M"					
For custom colors	Add - Black, -Grey, -Yellow, or -Orange to the end of the part #					

QUICK-CONNECT SENSOR CABLES HAVE A LOW PRICE,  
AND THOUSANDS IN STOCK FOR SAME DAY SHIPPING.





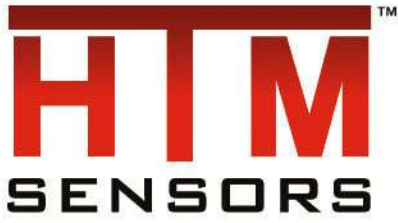

- FACTORY PRE-INSTALLED SILICONE CABLES FOR DURABILITY
- SILICONE JACKET TO PROTECT FROM HEAT, CUTS AND SPATTER
- LED'S ON THE END FOR FAST AND EASY TROUBLESHOOTING
- PTFE COATED NUTS FOR SPATTER RESISTANCE
- INSIDE CABLE IS MADE OF TPE FOR EXTENDED DURABILITY
- IDEAL FOR USE IN WELD CELLS WHERE CABLES CAN GET DAMAGED



## FACTORY PRE-INSTALLED SILICONE CABLES SPECIFICATIONS



	DOUBLE-ENDED	DOUBLE-ENDED	DOUBLE-ENDED	DOUBLE-ENDED	SPLITTER
	Double-Ended Cable	Double-Ended Cable	Double-Ended Cable	Double-Ended Cable	Splitter Cable
Male Connector	straight	straight	angled	angled	straight
Female Connector	straight	angled	straight	angled	straight
Cable Material	TPE	TPE	TPE	TPE	TPE
Protective Cable Jacket	Silicone Tube	Silicone Tube	Silicone Tube	Silicone Tube	Silicone Tube
Locking Nuts	PTFE Coated	PTFE Coated	PTFE Coated	PTFE Coated	PTFE Coated
LED on Female End	Power and Output	Power and Output	Power and Output	Power and Output	
M12, 4-pin - 0.6 m PNP	R-MS4TZ-T070.6+ R-FS4/3TP-T070.6-S	R-MS4TZ-T070.6+ R-FA4/3TP-T070.6-S	R-MA4TZ-T070.6+ R-FS4/3TP-T070.6-S	R-MA4TZ-T070.6+ R-FA4/3TP-T070.6-S	
M12, 4-pin - 0.6 m no LED	R-MS4TZ-T070.6+ R-FS4TZ-T070.6-S	R-MS4TZ-T070.6+ R-FA4/3TZ-T070.6-S	R-MA4TZ-T070.6+ R-FS4/3TZ-T070.6-S	R-MA4TZ-T070.6+ R-FA4/3TZ-T070.6-S	U2-R4R-FS4KZ- T070.6-S
M12, 4-pin- 2.0 m PNP	R-MS4TZ-T072+ R-FS4/3TP-T072-S	R-MS4TZ-T072+ R-FA4/3TP-T072-S	R-MA4TZ-T072+ R-FS4/3TP-T072-S	R-MA4TZ-T072+ R-FA4/3TP-T072-S	
M12, 4-pin - 2.0 m no LED	R-MS4TZ-T072+ R-FS4TZ-T072-S	R-MS4TZ-T072+ R-FA4TZ-T072-S	R-MA4TZ-T0702+ R-FS4TZ-T072-S	R-MA4TZ-T0702+ R-FA4TZ-T072-S	U2-R4R-FS4KZ- T072-S
NPN is available, change "P" to "N" in part number					
Custom lengths and connector styles are available					
M8 connectors are available on either or both ends					

FACTORY PRE-INSTALLED SILICONE CABLES ARE THE BEST CHOICE FOR EXTRA DURABILITY IN WELD CELLS WHERE CABLES ARE EXPOSED TO HIGH HEAT, WELD SPATTER, AND SHARP TOOLS OR PARTS.





**HTM**<sup>TM</sup>  
**SENSORS**



- FIELD CONNECTORS FOR QUICK CABLE REPAIRS AND CONNECTIONS
- LOW PRICES WITH THOUSANDS IN STOCK FOR SAME-DAY SHIPPING
- METAL SCREW TERMINALS FOR A TIGHT CONNECTION
- AVAILABLE IN M12, M8 AND MINI SIZES
- PERFECT SOLUTION TO MATE CABLES TO DISTRIBUTION BLOCKS
- COMPATIBLE WITH DEVICENET BLOCK CONNECTIONS



# FIELD CONNECTORS SPECIFICATIONS

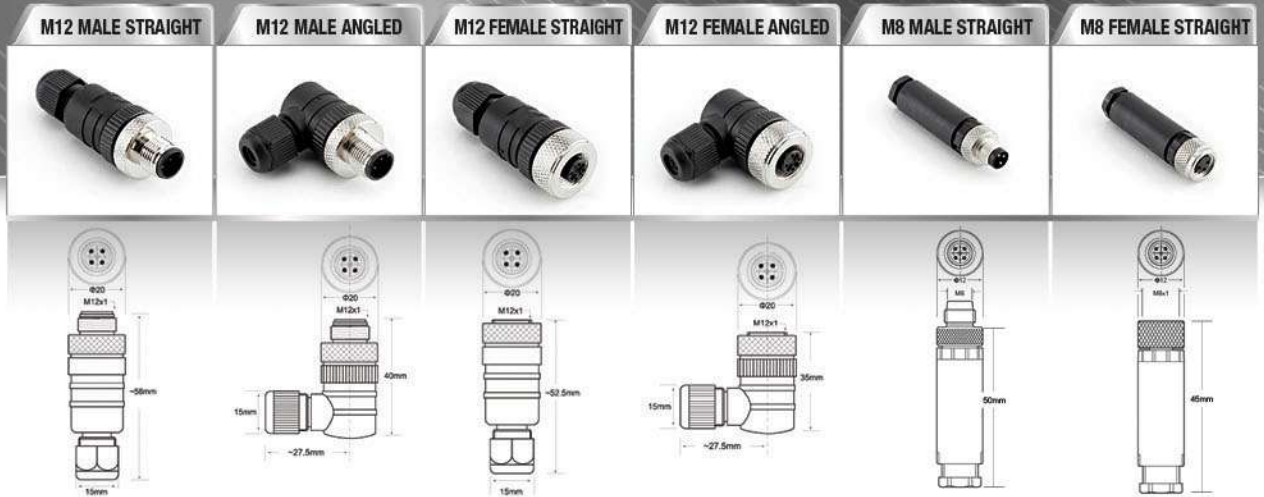

Application Class	HNA acc. to DIN 40040 (-40 °C to +90 °C ≤100%rF)				
Moulded Body	PA, Self-extinguishing				
Nominal Power	4 A				
Nominal Voltage	125 VAC/150 VDC				
Contact	CuZn, 2-4UM/CuSnZn				
O-Ring	NBR				
Lock Nut	Nickel-plated Brass				
Protection	IP67				
Connection Mode	Screw Clamps				
Insulation Group	C acc. to VDE 0110				
Test Voltage	1.25 KV, eff./60 s				
Insulation Resistance	>105 Ω				
<b>PART NUMBERS</b>					
M12 Micro - 4-Pin *	FC-12MS4P-PG7/9	FC-12MA4P-PG7/9	FC-12FS4P-PG7/9	FC-12FA4P-PG7/9	
M12 Micro - 5-Pin	R-MS5KZ/PG7	R-MA5KZ/PG7	R-FS5KZ/PG7	R-FA5KZ/PG7	
M12 AC - 3-Pin	U-MS3KZ/PG7	U-MA3KZ/PG7	U-FS3KZ/PG7	U-FA3KZ/PG7	
M8 Pico - 3-Pin					C-MS3KZ/SC      C-FS3KZ/SC
M8 Pico - 4-Pin					C-MS4KZ/SC      C-FS4KZ/SC

\* M12 Micro - 4-Pin connectors can be utilized in PG7 and PG9 applications. Stock one part for both sizes.

FIELD CONNECTORS ARE A QUICK AND INEXPENSIVE SOLUTION TO FIELD REPAIRS OF CABLES AND CONNECTIONS TO DISTRIBUTION BLOCKS.





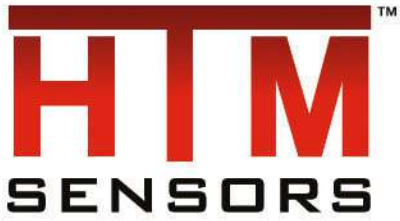

- DISTRIBUTION BLOCKS TO SIMPLIFY THE WIRING OF MACHINES
- AVAILABLE IN 4-PORT, 6-PORT, OR 8-PORT SIZES
- AVAILABLE WITH 7/8-16 OR M23 CONNECTOR
- AVAILABLE IN TOP PORTS OR SIDE PORTS
- AVAILABLE WITH NPN OR PNP LED'S
- FITS M12 FIELD CONNECTORS OR DOUBLE ENDED CABLE CONNECTIONS



# SENSOR CONNECTION DISTRIBUTION BLOCKS SPECIFICATIONS

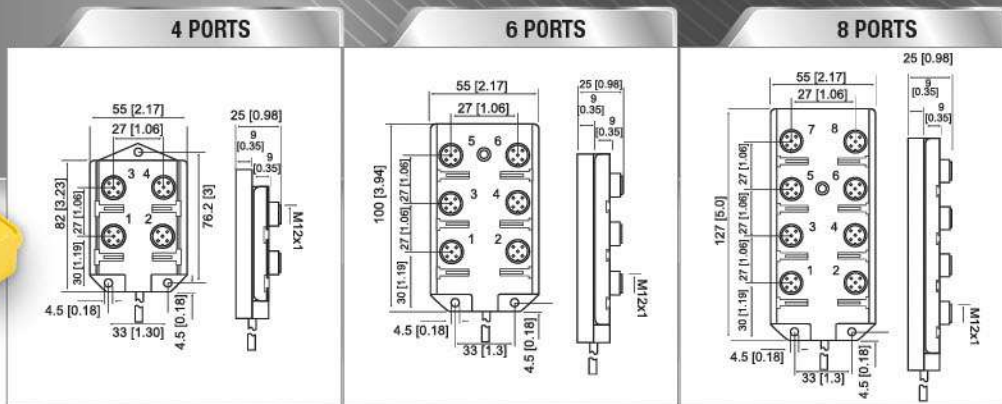

<b>Application Class</b>	-15 °C to +90 °C		
<b>Materials</b>			
Housing	Nylon		
Contact	Brass, Gold over Nickel Plating		
Receptacle Shell	Brass, Nickel Plating		
Insert	PUR		
O-Ring	Viton		
Cable Jacket	PUR		
<b>Electrical Data</b>			
Contact Resistance	≤5 mΩ		
Current Rating	4 Amps per outlet, Max. 12 Amps per box		
Working Voltage	10-30 VDC		
Insulation Resistance	>109 Ω		
<b>Mechanical Data</b>			
Contact	≤2.0 N (0.45 lbs)		
<b>Withdrawal Force</b>			
Contact	≥0.5 N (0.11 lbs)		
Protection	IP68, NEMA 6P (in fully locked position)		
Shock	IEC-68-2-27		
Vibration	IEC-68-2-6		
<b>CE Conformity</b>	EN50082-1, EN50082-2, IEC60947-5-2		
<b>PART NUMBERS</b>			
Without LEDs	ASTR4-5/4UZ-3005	DSTR6-5/4UZ-3305	DSTR8-5/4UZ-3205
NPN with LEDs - N.O.	ASTR4-5/4NA-3005	DSTR6-5/4NA-3305	DSTR8-5/4NA-3205
PNP with LEDs - N.O.	ASTR4-5/4PA-3005	DSTR6-5/4PA-3305	DSTR8-5/4PA-3205
PNP Dual input (2 LEDs)	ALTR4-5/5DC-3605	DLTR6-5/5DC-3405	DLTR8-5/5DC-3805
NPN Dual input (2 LEDs)	ALTR4-5/5EC-3605	DLTR6-5/5EC-3405	DLTR8-5/5EC-3805

SENSOR CONNECTION DISTRIBUTION BLOCKS ARE THE IDEAL SOLUTION TO REDUCE AND SIMPLIFY THE WIRING OF MACHINES FOR QUICK CHANGES AND REPLACEMENTS.





**HTM**<sup>TM</sup>  
**SENSORS**

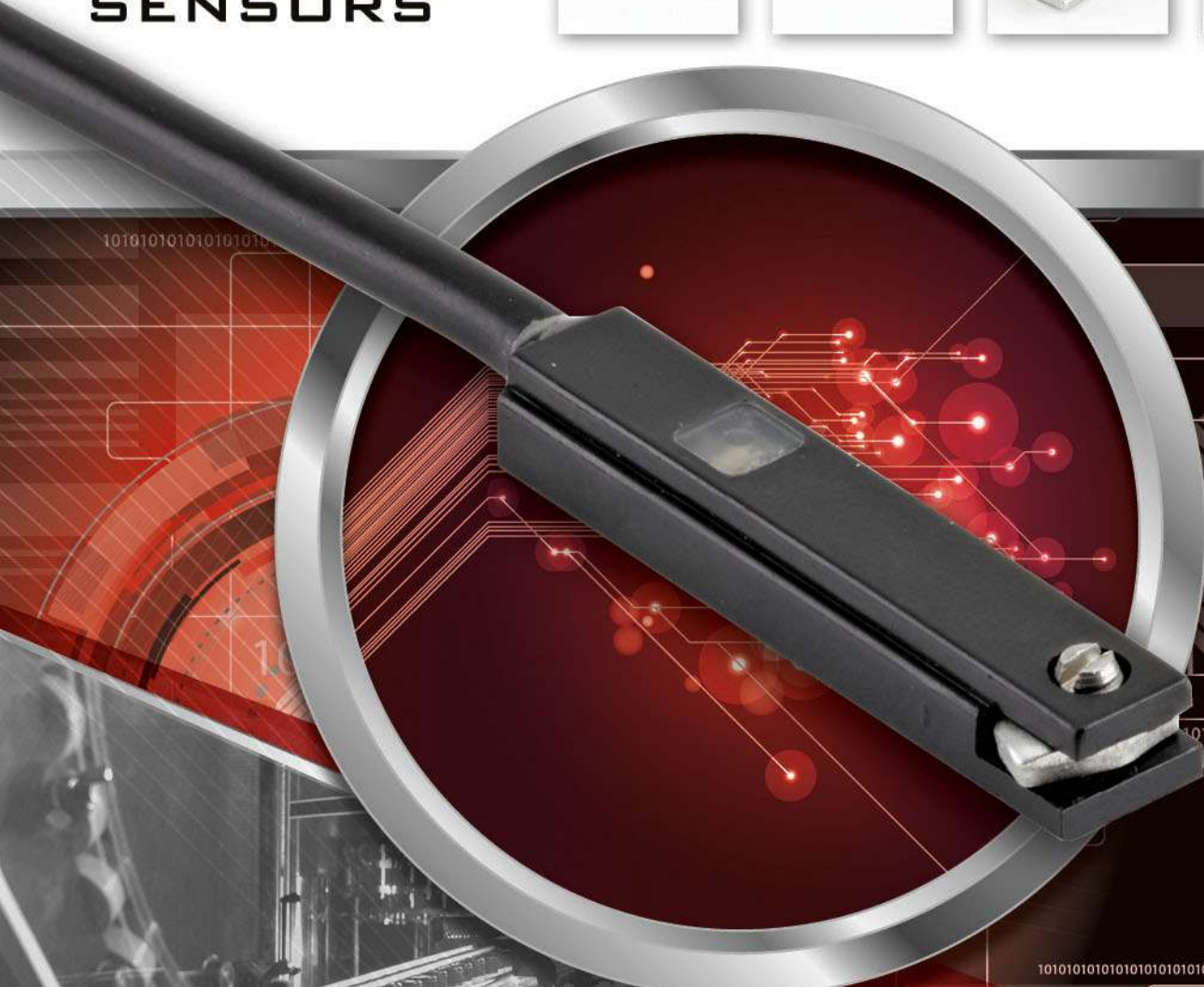
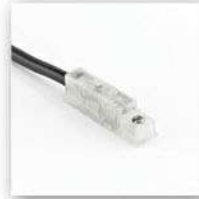

- PNEUMATIC CYLINDER SENSORS FOR THE RELIABLE CONTROL OF PNEUMATIC ACTUATORS
- SLIM FIT PLASTIC HOUSINGS FOR EASY MOUNTING, OR RUGGED METAL HOUSINGS FOR TOUGH APPLICATIONS
- MOUNTING FOR POPULAR ACTUATOR PROFILES INCLUDING T-SLOT, C-SLOT, DOVETAIL AND TUBULAR
- DROP-IN REPLACEMENTS FOR POPULAR FESTO® STYLE, SMC® STYLE, NUMATICS® STYLE AND CANFIELD® STYLE
- AVAILABLE WITH M8 OR M12 PIGTAIL CONNECTORS, OR WITH PRE-WIRED CABLES
- AVAILABLE WITH PNP, NPN OR REED OUTPUT



## PNEUMATIC CYLINDER SENSORS SPECIFICATIONS

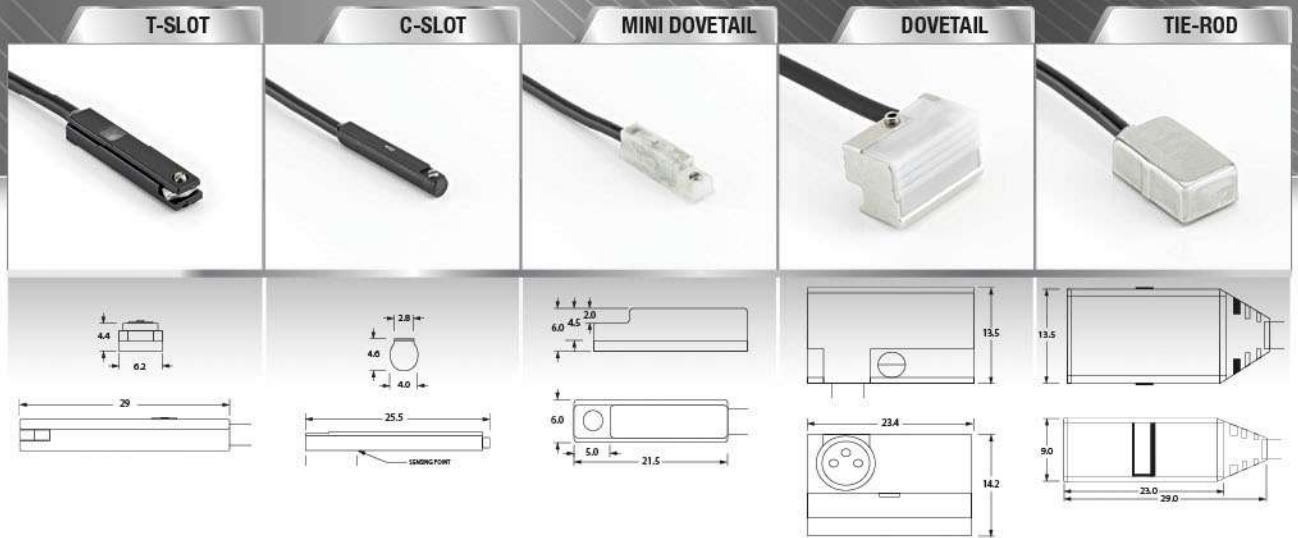

DIMENSIONS (mm)	6.2 W x 4.4 H x 29 L	4 W x 4.6 H x 25.5 L	6 W x 6 H x 21.5 L	11 W x 14 H x 23.4 L	13.5 W x 9 H x 23 L
SWITCHING VOLTAGE - PNP/NPN	5-28 VDC	5-28 VDC	5-28 VDC	5-28 VDC	6-24 VDC
SWITCHING VOLTAGE - REED	5-120 VAC/DC	5-120 VAC/DC	5-120 VAC/DC	5-120 VAC/DC	5-120 VAC/DC
CONNECTION	0.3 m PIGTAIL	0.3 m PIGTAIL	0.3 m PIGTAIL	0.3 m PIGTAIL	0.3 m PIGTAIL
CONNECTOR	M8 3-PIN CONNECTOR	M8 3-PIN CONNECTOR	M8 3-PIN CONNECTOR	M8 3-PIN CONNECTOR	M8 3-PIN CONNECTOR
<b>PART NUMBERS</b>					
PNP VERSION	PCST-06/29P-A3U0.3/P8	PCSC-04/25P-A3U0.3/P8	PCSD-06/21P-A3U0.3/P8	PSCH-11/23P-A3U0.3/P8	PSCR-13/23P-A3U0.3/P8
NPN VERSION	PCST-06/29N-A3U0.3/P8	PCSC-04/25N-A3U0.3/P8	PCSD-06/21N-A3U0.3/P8	PSCH-11/23N-A3U0.3/P8	PSCR-13/23N-A3U0.3/P8
REED VERSION	PCST-06/29R-A3U0.3/P8	PCSC-04/25R-A3U0.3/P8	PCSD-06/21R-A3U0.3/P8	PSCH-11/23R-A3U0.3/P8	PSCR-13/23R-A3U0.3/P8
MATING CABLE	C-FS3TZ-V075	C-FS3TZ-V075	C-FS3TZ-V075	C-FS3TZ-V075	C-FS3TZ-V075

HTM PNEUMATIC CYLINDER SENSORS ARE THE BEST CHOICE FOR THE MOTION CONTROL OF PNEUMATIC ACTUATORS FOR LINEAR, ROTARY OR GRIPPER CONTROL, WHERE A RELIABLE AND INEXPENSIVE SENSOR IS REQUIRED.





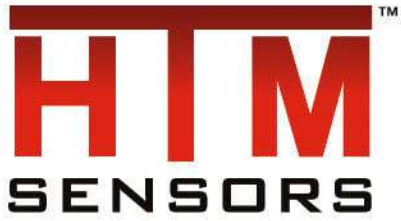

- SENSOR PROTECTION DEVICES FOR DOWNTIME REDUCTION
- QUICK-MOUNT COLLARS FOR SIMPLE TWIST-LOCK MOUNTING
- SPRING-MOUNTS TO PREVENT BREAKAGE ON CONTACT
- CONTACT PLUNGERS FOR A RELIABLE HARD STOP SWITCH
- SENSOR CAPS FOR SPATTER AND CONTACT PROTECTION
- AVAILABLE IN M8, M12, M18 AND M30 SIZES



## SENSOR PROTECTION DEVICES SPECIFICATIONS



	HARD STOP CONTACT PLUNGERS	QUICK-MOUNT COLLARS	SPRING MOUNTS	PROTECTIVE FACE CAPS
M8 SENSOR	HBSA-08-50-12	HQT-08	HSN-08	HSC-08
M12 SENSOR	HBSA-12-50-12	HQT-12	HSN-12	HSC-12
M18 SENSOR	HBSA-18-50-12	HQT-18	HSN-18	HSC-18
M30 SENSOR	HBSA-30-50-12	HQT-30	HSN-30	HSC-30
<b>DEVICE ACTION</b>	The sensor threads into the back of the device. When an object contacts the front of the spring mounted plunger, the plunger bolt moves into the sensing range of the sensor providing an output.	The sensor pushes into the back of the device to the collar at the front. The sensor is held in place with a twist of the collet nut. The face is protected, and the mounting distance is assured each time.	The sensor threads into the back of the device, and a plastic cap is threaded onto the sensor face. When an object hits the cap, the sensor moves backward and the spring action returns it to the original position.	The sensor is mounted freely, or inside a mounting device. The cap is threaded onto the face of the sensor. The cap protects the face of the sensor from heat, contact damage, abrasion, and weld spatter.

SENSOR PROTECTION DEVICES ARE CRITICAL FOR THE AGGRESSIVE ELIMINATION OF DOWNTIME, AND CAN BE BEST USED AS PART OF THE PROXWORX™ DOWNTIME REDUCTION SYSTEM.









## SILICONE WELD SPATTER PROTECTION SPECIFICATIONS



	HSCP-0375	HSCP-0500	HSCP-0750	HSCP-1000	Silicone Tape
Inside Diameter	3/8"	1/2"	3/4"	1"	1" wide
Outside Diameter	1/2"	5/8"	7/8"	1-1/8"	
<b>Temperature Rating</b>	<b>500 °F / 260 °C</b>				
Length	100 foot roll	50 foot roll	50 foot roll	50 foot roll	36 foot roll



CLEAR SILICONE TUBING AND SELF-FUSING SILICONE TAPE ARE PROVEN TO REDUCE DOWNTIME IN WELD CELLS BY PROTECTING CABLES, CONNECTORS AND SENSORS.



# PROXWorX™

COST REDUCTION VENDING

## DOWNTIME REDUCTION VENDING SYSTEM



## TOTAL COST SAVINGS WITH CONSIGNMENT SERVICE

- VENDOR MANAGED INVENTORY
- CONSIGNMENT STOCK
- CONTINUOUS IMPROVEMENT DATA
- AUTOMATED USAGE MONITORING

Proudly Supported by



In the USA: 1889 Maryland Ave., Niagara Falls, NY 14305  
In Canada: 3419 Mainway, Burlington, ON L7M 1A9

**Toll Free: 1-800-644-1756**



For technical support, or information about the Application, Selection, Installation and Protection of sensor products:

[support@htmsensors.com](mailto:support@htmsensors.com)

For customer service, or information about new and existing orders, shipment tracking, and product feedback:

[service@htmsensors.com](mailto:service@htmsensors.com)

For sales, or for volume pricing, distribution enquiries, product samples and on-site demonstrations:

[sales@htmsensors.com](mailto:sales@htmsensors.com)

