

# Y800Plus

## Universal Digital Meter

### Series 2

# INSTRUCTION MANUAL



Now with Ethernet



**YOKOGAWA**   
Yokogawa Corporation of America

2 Dart Rd, Newnan, GA 30265, USA  
Phone: 770-251-8700, Fax: 770-251-2088  
<http://www.yca.com>

# 1. ORDERING GUIDE

Configure a model number in this format: **Y820201DCV1, CBL01**

**Y8**.....Digital panel meter with screw terminal connectors.

**Display Color**  
**1**.....DPM with green LED  
**2**.....DPM with red LED  
**3**.... Extended DPM, green LED  
**4**..... Extended DPM, red LED

**Note:** Extended adds rate of change & linearization of non-linear inputs. Not applicable to thermocouple or RTD inputs.

**Power**  
**0**..... 85-264 Vac or 90-300 Vdc  
**1**..... 10-48 Vdc or 12-32 Vac

**Setpoint Output**  
**0**..... None  
**1**..... Two 8A contact relays  
**2**..... Two solid state relays  
**3**..... Four 8A contact relays  
**4**..... Four solid state relays

**Analog Output**  
**0**..... None  
**1**..... 4-20 mA, 0-10V, -10/+10V

**Digital Interface**  
**0**..... None  
**1**..... RS232  
**2**..... RS485  
**4**..... RS485-Modbus  
**5**..... USB  
**6**..... USB-to-RS485 converter  
**7**..... Ethernet  
**8**.. Ethernet-to-RS485 converter

**Input Type**  
**DC Volts**  
**DCV1** ..... 200.00 mV  
**DCV2** ..... 2.0000 V  
**DCV3** ..... 20.000 V  
**DCV4** ..... 200.00 V  
**DCV5\*** ..... 600.0 V  
**DCV6** ..... 300.0 V

\* Range not ETL approved.

**DC Amperes**  
**DCA1** ..... 2.0000 mA  
**DCA2** ..... 20.000 mA  
**DCA3** ..... 200.00 mA  
**DCA4** ..... 5.000 A

**RTDs**  
**P385C** ... Pt100, -202 to 850°C  
**P385F** ..Pt100, -331 to 1562°F  
**P392C**... Pt100, -202 to 850°C  
**P392F** ..Pt100, -331 to 1562°F  
**N672C**.... Ni120, -80 to 260°C  
**N672F** ... Ni120, -112 to 500°F  
**C427C**.... Cu10, -202 to 850°C  
**C427F** ...Cu10, -331 to 1562°F

**Thermocouples**  
**JC** .....-210 to 760°C  
**JF**.....-347 to 1400°F  
**KC**.....-244 to 1372°C  
**KF** .....-408 to 2501°F  
**TC** .....-257 to 400°C  
**TF** .....-430 to 752°F  
**EC** .....-240 to 1000°C  
**EF** .....-400 to 1830°F  
**NC**.....-245 to 1300°C  
**NF** .....-410 to 2370°F  
**SC** .....-46 to 1768°C  
**SF** .....-51 to 3214°F  
**RC** .....-45 to 1768°C  
**RF** .....-49 to 3213°F

**Resistance**  
**R1** ..... 0 to 20.000 ohms  
**R2** ..... 0 to 200.00 ohms  
**R3** ..... 0 to 2.0000 kohms  
**R4** ..... 0 to 20.000 kohms  
**R5** ..... 0 to 200.00 kohms

**Process Signals**  
(4-20 mA, 0-10V, etc.)  
**P** ..... 4-20 mA = 0-100.00  
**P1**.....Custom Scaling  
Specify min signal & reading, max signal & reading.

**Strain Gauge, Potentiometer**  
(4-wire ratio)  
**SG**..... 0-200 mV = 0-100.00  
**SG1**.....Custom Scaling

Specify min signal & reading, max signal & reading. Full-scale ranges 200 mV to 20V.

**RMS Volts**  
**RMV1** ..... 200.00 mV  
**RMV2** ..... 2.0000 V  
**RMV3** ..... 20.000 V  
**RMV4** ..... 200.00 V  
**RMV5\*** ..... 600.0 V  
**RMV6** ..... 300.0 V

**RMS Amperes**  
**RMA1** ..... 2.0000 mA  
**RMA2** ..... 20.000 mA  
**RMA3** ..... 200.00 mA  
**RMA4** ..... 5.000 A

**Load Cells** (6-wire ratio)  
**WM1**.....-99,999 to +99,999  
Specify min input signal & displayed reading, and max input signal & displayed reading. Full-scale inputs 20 mV to 500 mV. 10 Vdc excitation.

**Options & Accessories**  
**BL** .....Blank lens, no button pads.  
**CBL01**...RJ11-to-DB9 RS232 cable. Connects meter to PC com port.

**CBL02**...USB-to-DB9 adapter. For use with CBL01.  
**CBL05**...USB-cable, A to B. Connects meter to PC USB port.  
**IPC** .....NEMA4 panel cover.  
**BOX1** ....NEMA4 wall-mount enclosure.  
**BOX2** ....BOX1 plus IPC.

## 2. TABLE OF CONTENTS

1.	ORDERING GUIDE .....	2
2.	TABLE OF CONTENTS.....	3
3.	PRODUCT INTRODUCTION.....	4
4.	RECEIVING & UNPACKING .....	5
5.	SAFETY CONSIDERATIONS.....	5
6.	CONNECTOR WIRING INFORMATION .....	6
7.	MECHANICAL ASSEMBLY .....	8
8.	FRONT PANEL SETUP KEYS .....	10
9.	ENABLING & LOCKING OUT MENU ITEMS .....	12
10.	READING COORDINATES OF 2 POINTS SCALING METHOD.....	13
11.	DC VOLTS, AMPS, PROCESS, STRAIN INPUT.....	14
12.	LOAD CELL & MICROVOLT INPUT.....	20
13.	AC RMS VOLTS & AMPS INPUT .....	25
14.	THERMOCOUPLE INPUT .....	31
15.	RTD & RESISTANCE INPUT.....	34
16.	DUAL & QUAD RELAY OUTPUT OPTIONS .....	39
17.	ANALOG OUTPUT OPTION .....	42
18.	SERIAL COMMUNICATION OPTIONS .....	43
19.	EXCITATION OUTPUT & POWER SUPPLY.....	48
20.	INSTRUMENT SETUP VIA PC.....	49
21.	CUSTOM CURVE LINEARIZATION.....	52
22.	METER CALIBRATION .....	54
23.	SPECIFICATIONS.....	55
24.	GLOSSARY OF TERMS.....	59
25.	WARRANTY .....	64

### 3. PRODUCT INTRODUCTION

**Our digital panel meters** are versatile, cost effective solutions to a wide variety of monitoring and control applications. Depending on the choice of signal conditioner, they are easily set up for an accurate display of temperature, pressure, flow, weight, voltage or current, all in appropriate engineering units and with zero and span adjustment when needed. Setup can be via front panel pushbuttons or the meter's serial interface. Selective security lockout of the front panel keys protects against accidental changes to meter setup.

**High read rates** up to 60 per second (50 for 50 Hz operation) are made possible by Concurrent Slope Conversion (Pat 5,262,780), which integrates the signal over an AC power line cycle for maximum noise rejection. High read rates provide accurate peak and valley capture, and quick response for control applications. An adaptive digital filter supplies a time constant for the encountered signal noise level, yet responds rapidly to changes that exceed a selected threshold. Self-calibration occurs automatically after every 17th reading.

**The standard power supply** is a high-efficiency switching unit that operates from AC or DC, and allows the meters to be powered from worldwide AC without changes. A low-voltage supply is optional for power from 10-48V batteries or from 12-30 Vac. Both supplies provide an isolated 5, 10 or 24Vdc transducer excitation output.

**The meter case** conforms to the 1/8 DIN size standard. It is made of high impact, 94V-0 UL-rated plastic and is watertight to NEMA-4 (IP65) when panel mounted. Mounting is from the front of the panel and requires less than 110 mm behind the panel. Power and signal wiring is via removable plugs conforming to UL61010C safety standards. All output options are isolated from meter and power ground to 250 Vac.

**Extended meter versions** can linearize nonlinear inputs. Up to 180 data points may be linearized by a computer program that stores setup parameters in nonvolatile memory. Extended meters can also display rate of change, for example to display flow rate based on changing tank level.

**Alarm or setpoint control** is provided by an optional relay board with two or four Form C 8A mechanical relays or two or four Form A 120 mA solid state relays. The setpoints may be latching or non-latching, be energized above or below the setpoint, or operate in a fail-safe mode. The relays can operate from the filtered signal to reduce relay chatter or from the unfiltered signal for fastest response. Snubber circuits and a programmable relay switching time delay extend relay contact life.

**An isolated analog output** of 4-20 mA, 0-20 mA, 0-10V or -10 to +10V can be provided by an optional analog output board. The output is linearized to the display and can operate from the filtered or unfiltered signal input. It can be scaled via front panel pushbuttons or the meter's serial interface.

**Ethernet USB, RS232, or RS485** (2-wire half-duplex or 4-wire full-duplex) serial communications options are available with the Modbus protocol or a simpler custom ASCII protocol. Modbus operation includes RTU or ASCII modes, up to 247 digital addresses, and up to 32 devices per RS485 line without a repeater. Ethernet-to-RS485 and USB-to-RS485 converter boards allow a meter to be interfaced to a PC and to multiple meters on an RS485 network.

**Meter programming** can be via the meter's front panel or a PC running Windows based Instrument Setup Software (serial interface option required).

## 4. RECEIVING & UNPACKING

Your meter was carefully tested and inspected prior to shipment. Should the meter be damaged in shipment, notify the freight carrier immediately. In the event the meter is not configured as ordered or the unit is inoperable, return it to the place of purchase for repair or replacement. Please include a detailed description of the problem.

## 5. SAFETY CONSIDERATIONS



**Warning:** Use of this equipment in a manner other than specified may impair the protection of the device and subject the user to a hazard. Visually inspect the unit for signs of damage. If the unit is damaged, do not attempt to operate.

### Caution:

- The unit must be connected to a Disconnect switch or a branch-circuit breaker, which must be in a suitable location
- This unit must be powered by 85-264 Vac with the high voltage power supply option, or 10-48 Vdc (12-32 Vac) with the low voltage power supply option. Verify that the proper power option is installed for the power to be used. This meter has no On/Off switch. It will be in operation as soon as power is connected.
- The 85-264 Vac power connector (P1 Pins 1-3) is colored Green to differentiate it from other input and output connectors. The 12-32 Vac (10-48 Vdc) power connector is colored Black.
- Do not make signal wiring changes or connections when power is applied to the instrument. Make signal connections before power is applied. If reconnection is required, disconnect power before such wiring is attempted.
- To prevent electrical or fire hazard, do not expose the instrument to excessive moisture.
- Do not operate the instrument in the presence of flammable gases or fumes; such an environment constitutes a definite safety hazard. This meter is designed to be mounted in a metal panel or a bench or wall mount style case. The spacing around the meter and the ventilation must be sufficient to maintain the ambient temperature at less than 55°C.
- Verify the panel cutout dimensions, and mount according to instructions.

### Symbols used



Caution (refer to accompanying documents)



Earth (ground) terminal.



Caution, risk of electric shock.



Both direct and alternating current.



Equipment protected throughout by double insulation or reinforced insulation.

### Operating environment:

The meter is Class II (double insulated) equipment designed for use in Pollution degree 2.

## 6. CONNECTOR WIRING INFORMATION

### CONNECTORS

Connectors for signal and power are UL-rated screw-clamp terminal blocks that plug into mating jacks on the printed circuit board. Communication connectors are a single RJ11 plug for RS232, dual RJ11 plugs for RS485, dual RJ45 plugs for RS485 Modbus, or USB.

#### P1 - POWER AND DIGITAL CONTROLS

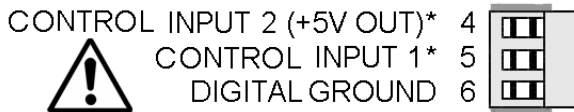
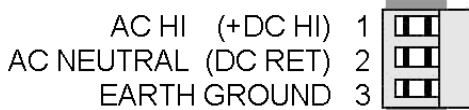

**Warning:** Hazardous voltages may be present on pins 4, 5 & 6 of P1 since digital ground is tied to pin 3 of P5 (-Signal Input). Keep pin 3 close to earth ground to minimize common mode voltage or shock hazard at pins 4, 5 & 6 of P1.

#### P5 - SIGNAL INPUT

##### DC & PROCESS

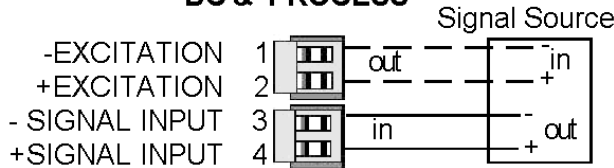

##### 2 WIRE PROCESS TRANSMITTER

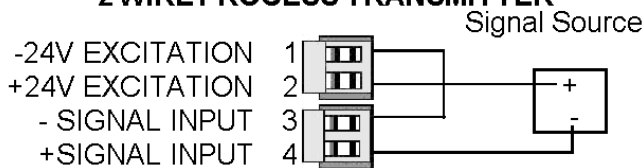

##### STRAIN GAUGE VOLTAGE SIGNAL IN

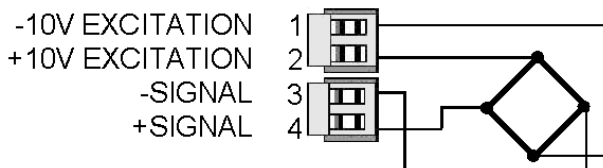

##### AC (TRUE RMS)

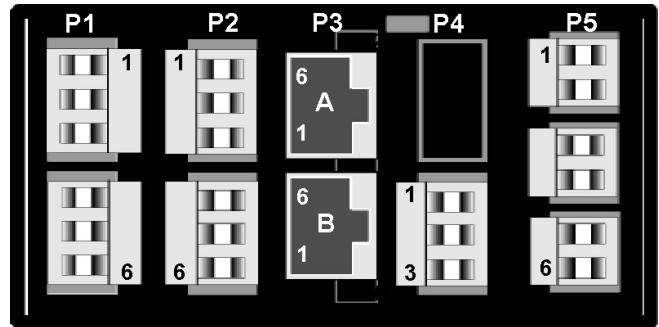
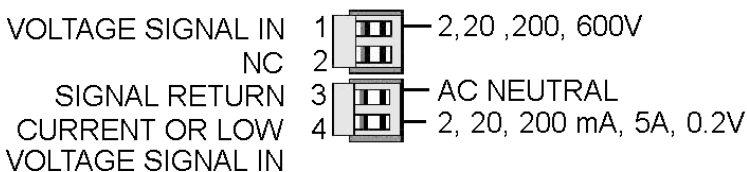

**Note:** Control inputs 1 & 2 of P1 are menu selectable.

#### LOAD CELL METER

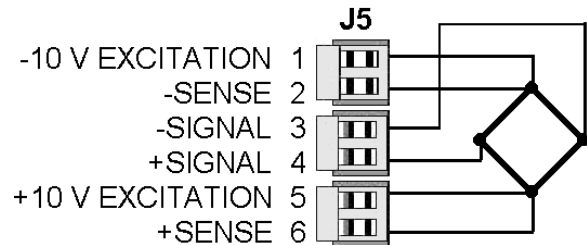

#### RTD & OHMS (2-WIRE)

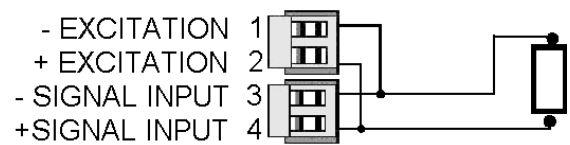

#### RTD & OHMS (3-WIRE)

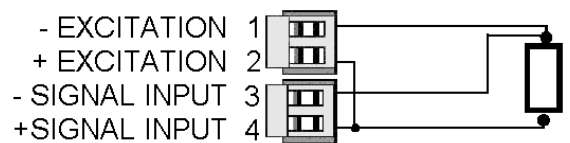

#### RTD & OHMS (4-WIRE)

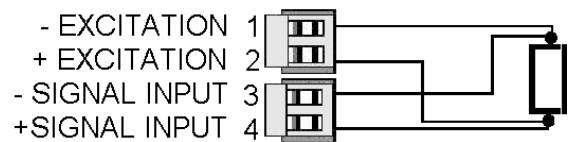

#### THERMOCOUPLE

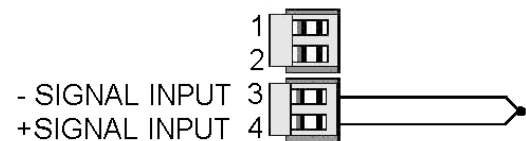

## P2 - SETPOINT CONTROLLER

### DUAL MECHANICAL RELAY OUTPUTS



### DUAL SOLID STATE RELAY OUTPUTS

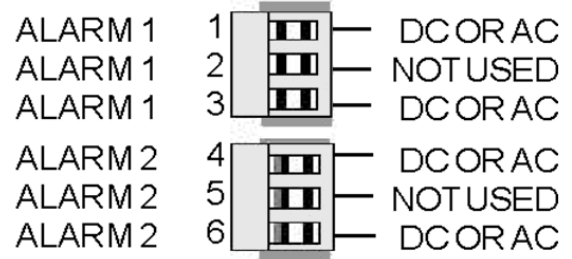

### QUAD MECHANICAL RELAY OUTPUTS

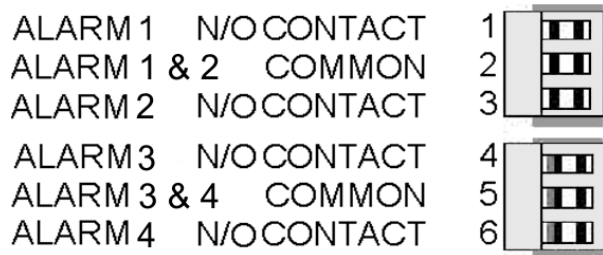

### QUAD SOLID STATE RELAY OUTPUTS

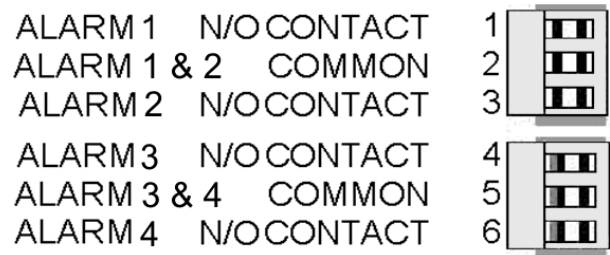

## P3 - SERIAL COMMUNICATIONS

### RS232 INTERFACE

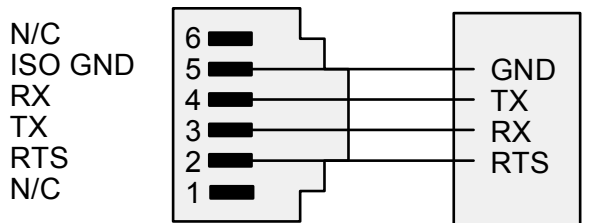

### UNIPOLAR CONNECTIONS

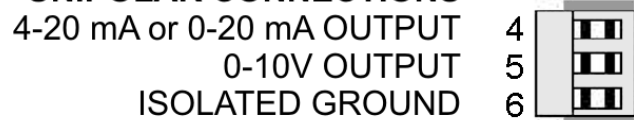

### BIPOLAR CONNECTIONS

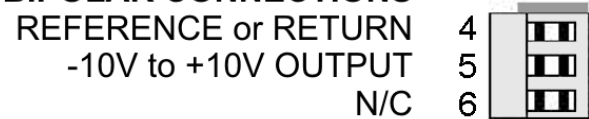

### RS485 INTERFACE - FULL DUPLEX

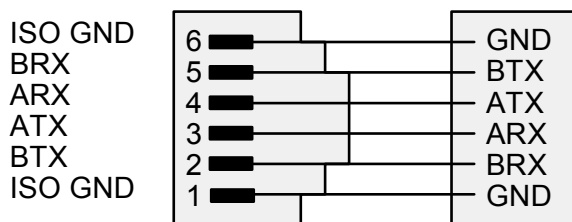

### RS485 INTERFACE - HALF DUPLEX

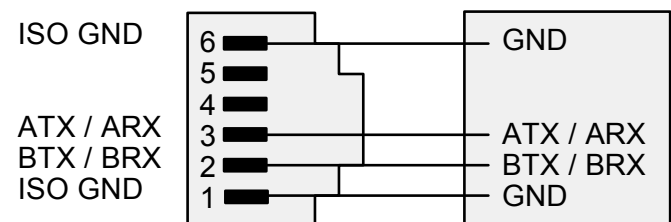

### RS485-MODBUS - FULL DUPLEX

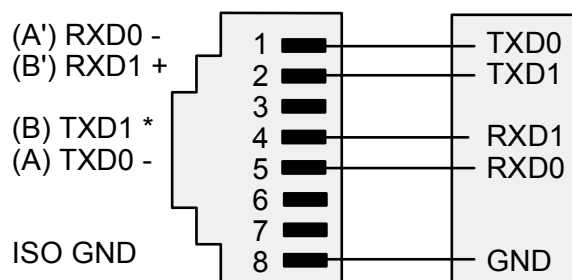

### RS485-MODBUS - HALF DUPLEX

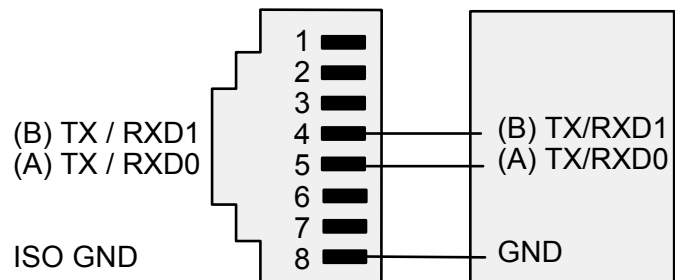

## 7. MECHANICAL ASSEMBLY

### REMOVING THE REAR PANEL

First remove any connectors. Use one hand to press in the two sides of the rear of the case, and the other hand to press down the two protruding tab releases at the top of the rear panel (see figure below). This will unhook the rear panel from the case.

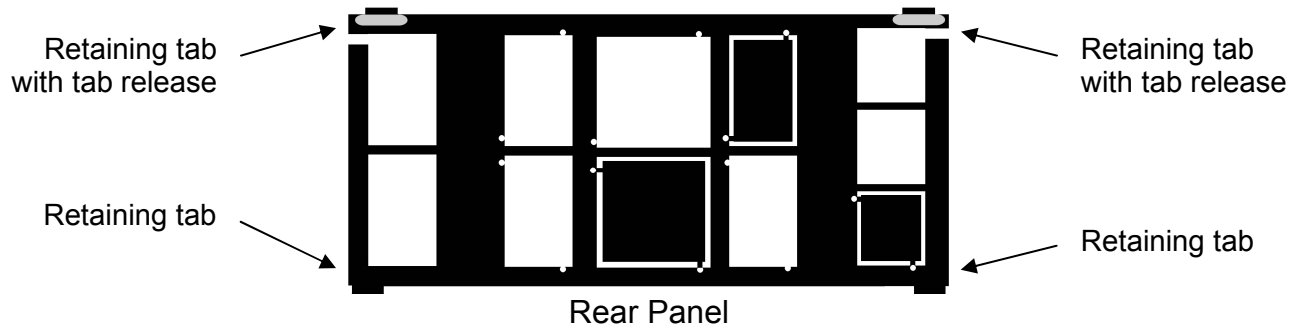

### REMOVING THE ELECTRONICS

With the rear panel removed, grasp the power supply board to the left and signal conditioner board to the right, and carefully slide the electronic assembly out through the rear of the case. (see figure below).

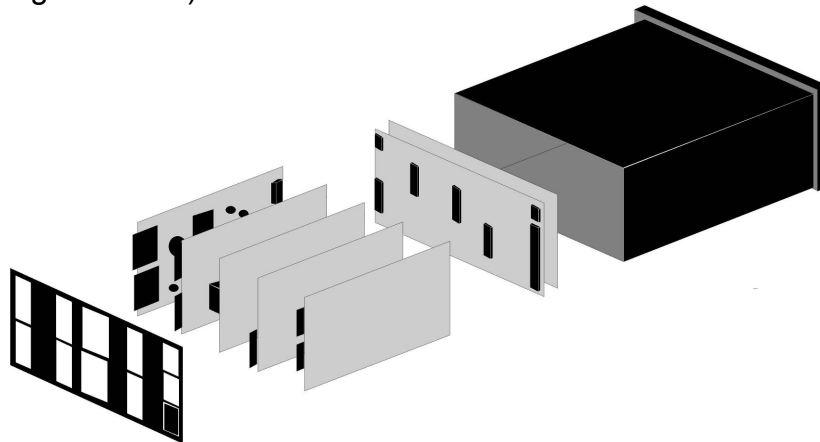

### INSTALLING NEW OPTION BOARDS

Options boards plug into the main board at the front of the meter. These are plug-and-play and may be installed in the field. They will be recognized by the software, which will provide access to the menu items associated with that board. If necessary, remove rear panel knockouts for new boards. Boards plug into connectors as follows:

Option Board	Main Board Plug	Rear Panel Jack
Power supply	P11	J1
Relay board	P12	J2
Serial interface board	P13	J3
Analog output board	P14	J4
Signal conditioner board	P15	J5



**Note:** Corresponding main board and option board connectors have the same number of electrical lines. When an option board is correctly installed, the top and bottom edges of the main board and option board are aligned.

### REASSEMBLING YOUR METER

Slide the electronics assembly into the case until the display board is seated flush against the front overlay. Insert the bottom tabs of the rear panel into the case, and then carefully align the board connectors with the openings in the rear panel. If necessary, remove any rear panel knockouts for new option boards that may have been installed. Ensure that all option boards are properly aligned with the molded board retaining pins on the inside of the rear panel. Once the rear panel is in place, reinstall the input/output screw clamp terminal plugs.

### PANEL MOUNTING

Ensure that the panel mounted gasket is in place against the back of the bezel. Turn the two mounting screws counterclockwise until the space between the mounting pawl and the rear of the gasket is greater than the panel thickness. Insert the meter in the panel cutout. Turn the mounting screws clockwise until the meter is securely mounted in the panel. Do not overtighten.

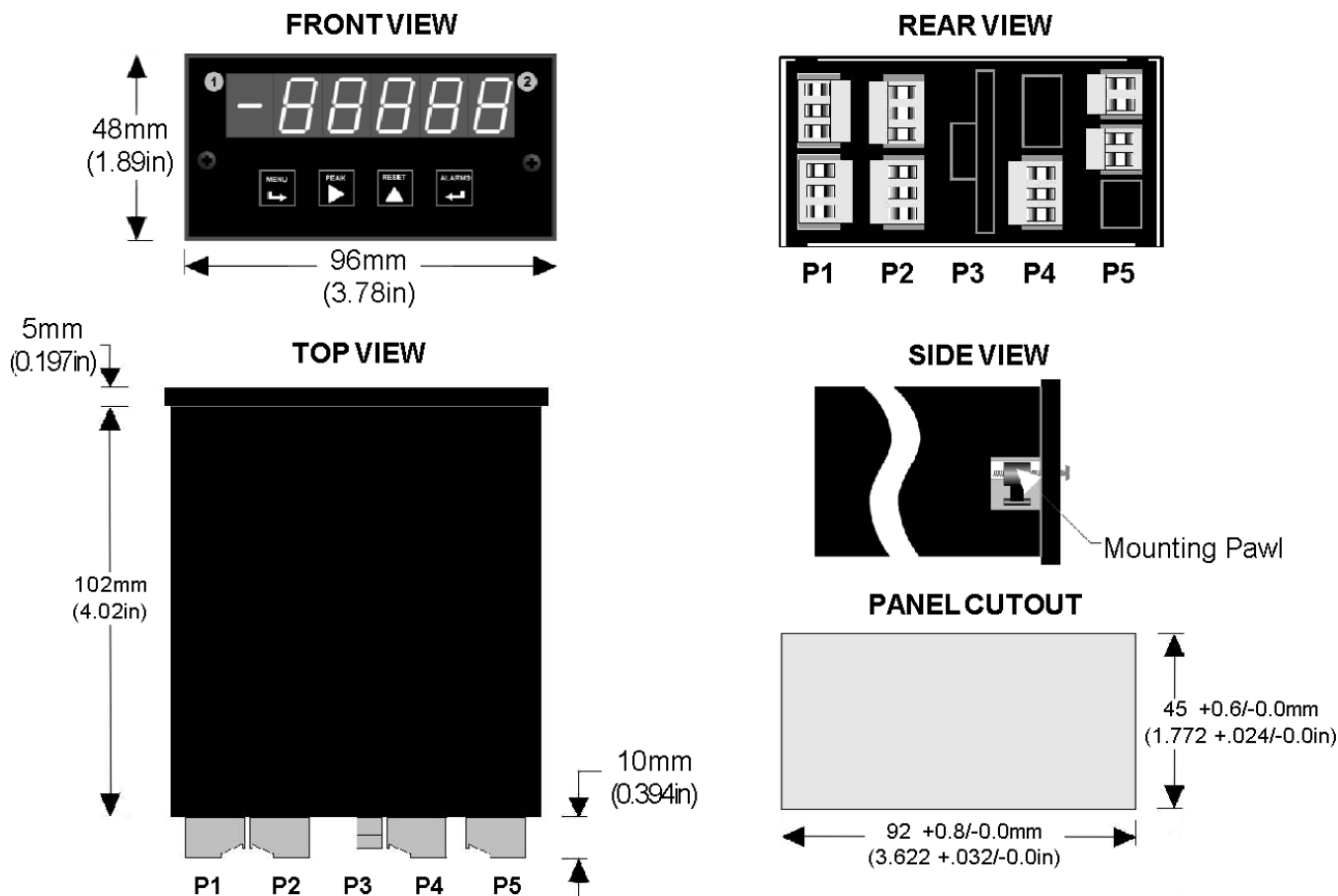

*Dimensioned case drawings*

## 8. FRONT PANEL SETUP KEYS



*Meter Front Panel*

There are four front panel keys, which change function for the **Run Mode** and **Menu Mode**, effectively becoming eight keys. The keys are labeled with alphanumeric captions (MENU, PEAK, RESET, ALARMS) for the Run Mode and with symbols (➡ right arrow, ▶ right triangle, ▲ up triangle, ← left arrow) for the Menu Mode.

### FRONT PANEL LOCKOUT

The Menu Mode will not work with most meters as received from the factory, since all menu items have been disabled in software and a lockout jumper is in place. That jumper needs to be removed for the Menu Mode to work, and menu items under *Loc 1*, *Loc 2* and *Loc 3* then need to be set to "0" via the front panel for these menu items to be unlocked. See Section 9. The paragraphs below assume that all menu items have been unlocked.

### MENU MODE KEY ACTION

In the Menu Mode, pressing a key momentarily advances to the next menu item. Holding down a key automatically advances through multiple menu items for fast menu navigation.

### KEYS IN RUN MODE



**MENU Key.** Pressing *MENU* from the Run Mode enters the Menu Mode. Pressing *MENU* repeatedly will step the meter through the various menu items (if these have not been locked out) and then back to the Run Mode.



**PEAK Key.** Pressing *PEAK* normally causes the peak value of the input signal to be displayed. The peak display then blinks to differentiate it from the normal present value display. Pressing *PEAK* again returns the display to the present value. The *PEAK* key can also be programmed to display Valley, alternating Peak or Valley, or to Tare the reading to zero. When Peak or Valley is selected, periodic horizontal bars at the top of the display indicate Peak, and periodic horizontal bars at the bottom indicate Valley.





**RESET Key.** Pressing *RESET* with *PEAK* resets peak and valley values. Pressing *RESET* with *ALARMS* resets latched alarms. Pressing *RESET* with *MENU* performs a meter reset (same as power on). Meter reset can also be applied via a rear panel connect or a serial ASCII command.



**ALARMS Key.** Pressing *ALARMS* once displays the setpoint for Alarm 1. Pressing it again displays the setpoint for Alarm 2. Pressing it again returns to the present value.



## KEYS IN MENU MODE



**Right Arrow Key (MENU).** Pressing  steps the meter through all menu items that have been enabled and then back to the Run Mode. With the DC signal conditioner board and no option boards, available menu items are **InPut**, **SEtuP**, **ConFG**, **FiLtr**, **dEc.Pt**, **SCALE**, **OFFSt**, **Loc 1**, **Loc 2**, **Loc 3**. If a change has been made to a menu item, that change is saved to non-volatile memory when the  key is pressed next, and **StoreE** is displayed briefly.



**Right Triangle Key (Digit Select).**

- Pressing  from the *InPut* menu brings up all meter functions available with the meter's signal conditioner. For the DC signal conditioner, these are **dC U**, **dC A** and **rAtio**.
- Pressing  from the *SEtuP*, *ConFG*, *FiLtr*, *SCALE*, *OFFSt*, *Loc 1*, *Loc 2* or *Loc 3* menus items sequentially selects digit positions 1 - 5, as indicated by a flashing digit: **00000**, **00000**, **00000**, **00000**, **00000**.
- Pressing  from the *dEC.Pt* menu item sequentially selects decimal point positions, which will flash: **d\_ddd** **dd\_ddd** **ddd\_dd** **dddd\_d** **dddd\_d** **\_dddd**.



**Up Triangle Key (Value Select).** Pressing  for a flashing item (digit position or decimal point position) will increment that item. Pressing *MENU* will save any changes.



**Left Arrow Key (Reverse Menu).** Pressing  has the same effect as the *MENU* key, except that menu items are brought up in reverse order.

## 9. ENABLING & LOCKING OUT MENU ITEMS

For security reasons and ease of meter operation, any and all menu items may be disabled or "locked out" so that they are no longer directly accessible from the front panel. Each function to be disabled is set to "1" in menu items *Loc 1*, *Loc 2* or *Loc 3*, and each function to be enabled is set to "0." The top menu items *Loc 1*, *Loc 2* and *Loc 3* can in turn be locked out by installing an internal hardware jumper. With the jumper installed, the operator only has access only to enabled menu items. With the jumper removed, the operator also has access to menu items *Loc 1*, *Loc 2* and *Loc 3*.

### SETTING HARDWARE LOCKOUT JUMPER

To access the lockout jumper, remove the rear panel per Section 9 and locate jumper "a" in the lower portion of the power supply board next to the input connectors (see figure at right).

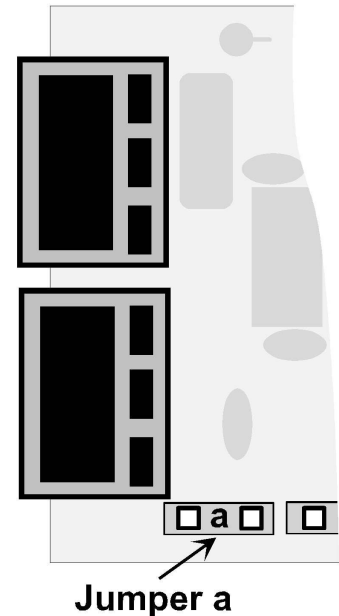

### SETTING SOFTWARE LOCKOUTS

When setting up the meter, it may be necessary to enable specific menu items by setting the corresponding lockout digit to 0. Be sure to reset the lockout digit to "1" if you do not want the menu item to be changed by an operator.

#### **Loc 1** **Loc 2** **Loc 3**

Press the **→** *MENU* key until *Loc 1*, *Loc 2* or *Loc 3* is displayed, as desired. **Note:** the hardware lockout jumper must be removed (see above).

#### **11111**

Press **▶** to display the lockout status, consisting of 1's and 0's. The left digit will flash. Press **▶** again to step to the next digit, which will flash.

#### **00000**

12345

Press **▲** to set the flashing digit to "0" to enable the menu item or to "1" to disable. Press *MENU* to enter. See the table to the right for list of menu items that can be enabled or disabled.

### Enabled or Disabled Menu Items

#### **Loc 1**

- 1 - Input type selection.
- 2 - Meter setup, configuration & decimal pt.
- 3 - Filter selection.
- 4 - Scale or Lo, Hi input.
- 5 - Offset or Lo, Hi reading

#### **Loc 2**

- 2 - Alarm setup.
- 3 - Alarm setpoint value programming.
- 4 - Analog output scaling.
- 5 - Serial interface setup.

#### **Loc 3**















- 2 - View peak value
- 3 - View alarm setpoints
- 4 - Reset (peak & latched alarms)
- 5 - Reset (meter reset)

## 10. READING COORDINATES OF 2 POINTS SCALING METHOD

When the *reading coordinates of 2 points* scaling method has been selected under **SEtUP**, the four menu items below will appear ahead of all other menu items when the *MENU* or  key is first pressed from the run mode.

This scaling method applies a straight line fit between two points, which are determined from actual transducer signals and the desired corresponding meter readings. A low signal, such as the output of a pressure transducer at zero pressure, and high signal, such as the output of the same transducer at a known high pressure, are applied to the meter. The desired corresponding low and high readings are then entered from the front panel. The meter then applies straight line fit between the high and low calibration points. This scaling method has the advantage of calibrating the transducer and meter as a system. The actual voltage or current at either point does not need to be known. This method is ideal for process and load cell meters, which require zero and span adjustment. It is also available for DC or AC meters. It is not available with thermocouple or RTD meters.

The programming example below is for a process meter used with a 4-20 mA pressure transducer for 0 to 100 psi. Decimal points are set separately using the *dEC.Pt* menu.

 <b>Press Menu Select Key</b>	 <b>Press Digit Select Key</b>	 <b>Press Value Select Key</b>
<b>Lo In</b> Apply low signal input (e.g., transducer output for 0 psi).	<b>40.21</b> Press  to display reading at low signal input (e.g., 4.021 mA).	<b>40.21</b> Press  to store low reading.
<b>Hi In</b> Apply high signal input (e.g., transducer output for known 100.00 psi source).	<b>200.94</b> Press  to display reading at high signal input (e.g., 20.094 mA).	<b>200.94</b> Press  to store high reading.
<b>Lo rd</b> Mode to enter desired low reading (e.g., 0.00).	<b>000.00</b> <b>000.00</b> <b>000.00</b> <b>000.00</b> <b>000.00</b> Select digit to flash.	<b>0.00</b> Select  thru  for flashing first digit,  thru  for other flashing digits.
<b>Hi rd</b> Mode to enter desired high reading (e.g., 100.00).	<b>000.00</b> <b>000.00</b> <b>000.00</b> <b>000.00</b> <b>000.00</b> Select digit to flash.	<b>100.00</b> Select  thru  for flashing first digit,  thru  for other flashing digits.

## 11. DC VOLTS, AMPS, PROCESS, STRAIN INPUT

The DC Volts, Amps, Process and Strain meters utilize the DC signal conditioner board, which needs to be configured via jumpers for the desired voltage or current range. All signal ranges are factory calibrated with calibration factors stored in EEPROM. The meter software recognizes the board and will bring up the appropriate menu items for it; however, it does not recognize the jumper settings. Please see further manual sections for setup of the following: relay output (16), analog output (17), communications (18), and excitation output (19).

### Board Revision N

#### Voltage Ranges      Jumpers

FS Input	E1	E2	E3
±200.00 mV	A	f	b
±2.0000 V	A	f	a
±20.000 V	B	h	b
±200.00 V	B	h	a
±300V (UL)	B	g	a
±600V (not UL)	B	g	a

#### Current Ranges      Jumpers

FS Input	E1	E2	E3
±2.0000 mA	A	e, g	b
±20.000 mA	A	d, g	b
±200.00 mA	A	c, g	b
±5.000 A	A	a, b, g	b

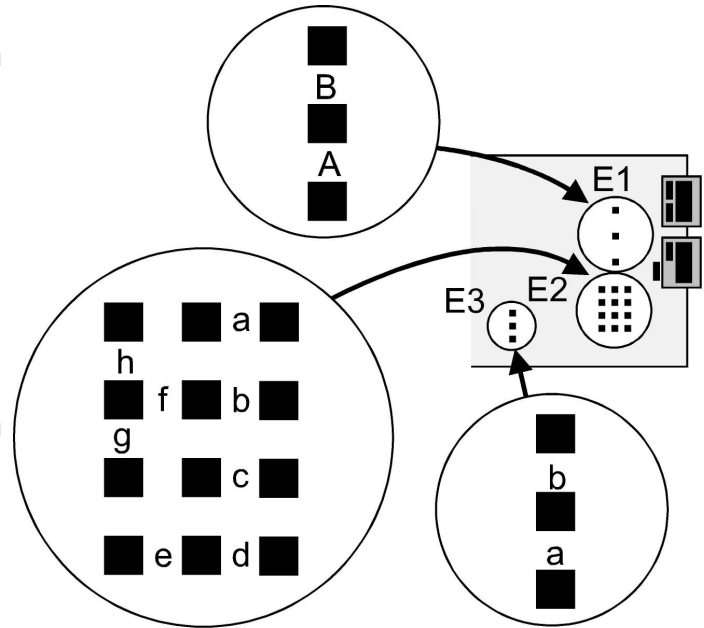

### Board Revision P (shipped between 15 Jan 2012 and 1 May 2012)

#### Voltage Ranges      Jumpers

FS Input	E1	E2
±200.00 mV	A	f
±2.0000 V	B	k
±20.000 V	B	j
±200.00 V	B	h
±300V (UL)	B	g
±600V (not UL)	B	g

#### Current Ranges      Jumpers

FS Input	E1	E2
±2.0000 mA	A	e, g
±20.000 mA	A	d, g
±200.00 mA	A	c, g
±5.000 A	A	a, b, g

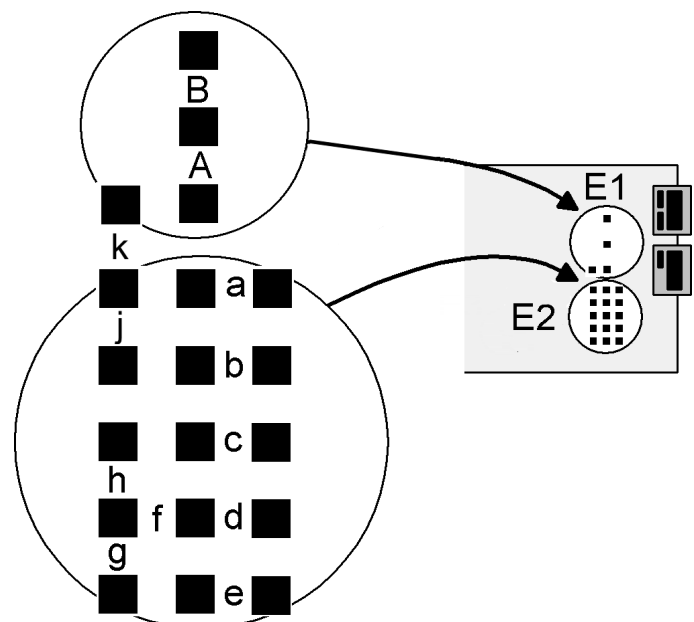

## Board Revisions Q and R

Voltage Ranges	Jumpers		
FS Input	E1	E2	E3
±200.00 mV	A	f	b
±2.0000 V	A	f	a
±20.000 V	B	h	b
±200.00 V	B	h	a
±300V (UL)	B	g	a
±600V (not UL)	B	g	a

Current Ranges	Jumpers		
FS Input	E1	E2	E3
±2.0000 mA	A	e, g	b
±20.000 mA	A	d, g	b
±200.00 mA	A	c, g	b
±5.000 A	A	a, b, g	b

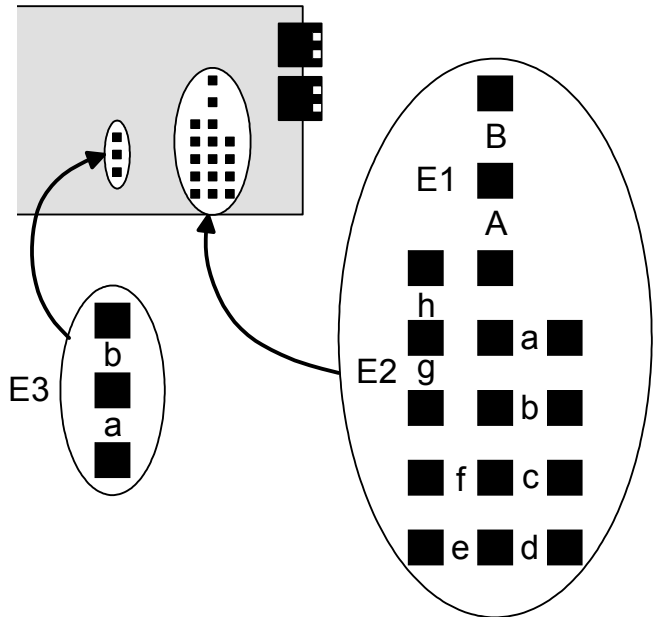

1. Letters indicate jumper position. Jumpers are installed on pins adjacent to letters.
2. Use 5 mm (0.2") jumpers for locations designated by a capital letter.
3. Use 2.5 mm (0.1") jumpers for locations designated by a lower case letter.
4. Store spare jumpers on an unused jumper post not associated a capital letter.



## SCALE & OFFSET SETUP

**For DC voltmeters & ammeters**, a scale factor of 1 and an offset of 0 are used for direct readings in (milli)volts or (milli)amperes. Decimal point selection does not affect the displayed digits. For example, 0-20V or 0-20 mA signals can both be displayed as 0-20000. A full scale of 20000 may be displayed as 20.000 mA or 20000  $\mu$ A. Use with a current shunt will require a scale factor to be set. For example, for a 500-100 (500A, 100 mV) shunt, divide 5000 (the desired full scale display with 0.1A resolution) by 10000 (displayed value with 100 mV when the scale factor is 1.0) for a scale factor of 0.5.



**For process & strain meters**, scaling is normally set up from the front panel using the ► and ▲ keys, but can also be set up via RS232/485 using special PC-compatible setup software (available at no charge). The meter allows three scaling methods to be selected: 1) *Scale and offset*, 2) *Coordinates of 2 points*, and 3) *Reading coordinates of 2 points*. Only menu items applicable to the selected method will be presented.

## KEYSTROKES FOR SETUP

If the *MENU*  key does not work, see Section 9 “Enabling & Locking Out Menu Items.”

 <b>Press Menu Select Key</b>	 <b>Press Digit Select Key</b>	 <b>Press Value Select Key</b>
<b>InPut</b> Selection of signal input type & range	<b>dC U</b> DC Volts	<b>0.2U</b> <b>2.0U</b> <b>20.0U</b> <b>200.0U</b> <b>600.0U</b> 0.2, 2, 20, 200, 660V FS
	<b>dC A</b> DC Amps	<b>2.0a</b> <b>20.0a</b> <b>200.0a</b> <b>5.0a</b> 0.2, 20, 200 mA, 5A FS
	<b>rAtio</b> Strain gauge & ratio	<b>0.2U</b> <b>2.0U</b> <b>20.0U</b> 0.2, 2, 20V FS.
<b>SEtuP</b> Meter Setup	<b>00_00</b> Display selection with scale factor of 1.	<b>0</b> 4-1/2 digits (±20,000) <b>1</b> Remote display (±99,999) <b>2</b> 4-1/2 digits, counts by 10 (±20,000) <b>3</b> 3-1/2 digits (±2,000)
	<b>00_00</b> Power line frequency	<b>0</b> Noise minimized for 60 Hz <b>1</b> Noise minimized for 50 Hz
	<b>00_00</b> Scaling method	<b>0</b> Scale and offset method <b>1</b> Coordinates of 2 points method <b>2</b> Reading coordinates of 2 points method
	<b>00_00</b> Control inputs 1 & 2: <b>True</b> = logic 1 (0V or tied to digital ground) <b>False</b> = logic 0 (5V or open)	<b>0</b> 1 = Reset, 2 = Meter Hold <b>1</b> 1 = Function Reset, 2 = Peak or Valley <b>2</b> 1 = Hold, 2 = Peak or Valley Display <b>3</b> 1 = Hold, 2 = Tare <b>4</b> 1 = Peak or Valley Display, 2 = Tare <b>5</b> 1 = Tare, 2 = Reset <b>6</b> 1 = 1, 2 = 1, decimal point = XXXXX 1 = 0, 2 = 1, decimal point = XXXX.X 1 = 1, 2 = 0, decimal point = XXX.XX 1 = 0, 2 = 0, decimal point = XX.XXX <b>7</b> 1 = 1, 2 = 1, decimal point = XXXX.X 1 = 0, 2 = 1, decimal point = XXX.XX 1 = 1, 2 = 0, decimal point = XX.XXX 1 = 0, 2 = 0, decimal point = X.XXXX <b>8</b> 1 = Function Reset, 2 = Display Blank <b>9</b> 1 = Hold, 2 = Display Blank <b>A</b> 1 = Peak or Valley, 2 = Display Blank <b>B</b> 1 = Tare, 2 = Display Blank <b>C</b> 1 = Valley Display, 2 = Peak Display <b>D</b> 1 = Tare, 2 = Reset Tare to Zero  Both inputs 1 and 2 set to logic 1 for selections <b>2, 4, A, C</b> = Function Reset Both inputs 1 and 2 set to logic 1 for selections <b>0, 1, 3, 5, 8, 9, B, D</b> = Meter Reset



 <b>Press Menu Select Key</b>	 <b>Press Digit Select Key</b>	 <b>Press Value Select Key</b>
<b>ConFG</b> Meter Configuration	<b>000_0</b> Operation as a rate of change meter. <i>Extended meter only.</i>	<b>0</b> Not rate of change <b>1</b> Rate x 0.1 <b>2</b> Rate x 1 <b>3</b> Rate x 10 <b>4</b> Rate x 100 <b>5</b> Rate x 1000 <b>6</b> Rate x 10000
	<b>000_0</b> Operation of front panel <b>PEAK</b> button and rear connector for Peak or Valley Display	<b>0</b> Peak Display. Also selects “Peak” in “Peak or Valley” at connector above. <b>1</b> Valley Display. Also selects “Valley” in “Peak or Valley” at connector above. <b>2</b> Peak (1st push), Valley (2nd push) <b>3</b> Front panel Tare
	<b>000_0</b> Auto-tare	<b>0</b> Meter comes up in normal run mode. <b>1</b> Meter comes up in auto-tare mode
	<b>000_0</b> Nonlinear input scaling <i>Extended meter only.</i>	<b>0</b> Linear input <b>1</b> Custom curve linearization
<b>FilTr</b> Filtering	<b>00000</b> Alarm filtering	<b>0</b> Unfiltered output <b>1</b> Filtered output
	<b>00000</b> Peak & Valley filtering	<b>0</b> Unfiltered Peak & Valley <b>1</b> Filtered Peak & Valley
	<b>00000</b> Display filtering	<b>0</b> Display batch average every 16 readings <b>1</b> Display filtered signal
	<b>00000</b> Adaptive filter threshold	<b>0</b> Low adaptive filter threshold level <b>1</b> High adaptive filter threshold level
	<b>00000</b> Input signal filtering. <i>Can be applied to display, setpoint, analog output, data output.</i>	<b>0</b> Autofilter <b>1</b> Batch average, 16 readings <b>2</b> Moving average, 0.08 sec. <b>3</b> Moving average, 0.15 sec. <b>4</b> Moving average, 0.3 sec. <b>5</b> Moving average, 0.6 sec. <b>6</b> Moving average, 1.2 sec. <b>7</b> Moving average, 2.4 sec. <b>8</b> Moving average, 4.8 sec. <b>9</b> Moving average, 9.6 sec. <b>A</b> Unfiltered
<b>dEc.Pt</b> Dec. point selection	<b>d.dddd</b> Decimal point flashes.	<b>d_ddd</b> <b>dd_ddd</b> <b>ddd_dd</b> <b>dddd_d</b> <b>dddd.</b> <b>_dddd</b> Press ▲ to shift the decimal point.

<b>MENU</b> 	<b>Press Menu Select Key</b>	<b>PEAK</b> 	<b>Press Digit Select Key</b>	<b>RESET</b> 	<b>Press Value Select Key</b>
--	----------------------------------	--	-----------------------------------	---	-----------------------------------

Scaling method "Scale and Offset" if selected under **SEtuP**

<b>SCALE</b> Scale factor	<b>0.0000</b> <b>0.0000</b> <b>0.0000</b> <b>0.0000</b> <b>0.0000</b> <b>0.0000</b> Select digit to flash.	Select <b>9</b> thru <b>9</b> for flashing first digit, <b>0</b> thru <b>9</b> for other flashing digits. Select decimal point location when decimal point is flashing.
<b>OFFst</b> Offset value	<b>0.0000</b> <b>0.0000</b> <b>0.0000</b> <b>0.0000</b> <b>0.0000</b> Select digit to flash.	Select <b>9</b> thru <b>9</b> for flashing first digit, <b>0</b> thru <b>9</b> for other flashing digits. Decimal point location is selected by <b>dEC.Pt.</b>

Scaling method "Coordinates of 2 points" if selected under **SEtuP**

<b>Lo In</b> Low signal input.	<b>0.0000</b> <b>0.0000</b> <b>0.0000</b> <b>0.0000</b> <b>0.0000</b> Select digit to flash.	Select <b>9</b> thru <b>9</b> for flashing first digit, <b>0</b> thru <b>9</b> for other flashing digits. Decimal point is set by input range chosen.
<b>Lo rd</b> Desired reading at Lo In.	<b>0.0000</b> <b>0.0000</b> <b>0.0000</b> <b>0.0000</b> <b>0.0000</b> Select digit to flash.	Select <b>9</b> thru <b>9</b> for flashing first digit, <b>0</b> thru <b>9</b> for other flashing digits. Decimal point is set by <b>dEC.Pt.</b>
<b>Hi In</b> High signal input.	<b>0.0000</b> <b>0.0000</b> <b>0.0000</b> <b>0.0000</b> <b>0.0000</b> Select digit to flash.	Select <b>9</b> thru <b>9</b> for flashing first digit, <b>0</b> thru <b>9</b> for other flashing digits. Decimal point is set by input range chosen.
<b>Hi rd</b> Desired reading at Hi In.	<b>0.0000</b> <b>0.0000</b> <b>0.0000</b> <b>0.0000</b> <b>0.0000</b> Select digit to flash.	Select <b>9</b> thru <b>9</b> for flashing first digit, <b>0</b> thru <b>9</b> for other flashing digits. Decimal point is set by <b>dEC.Pt.</b>

Scaling method "Reading coordinates of 2 points" if selected under **SEtuP**

<b>Lo In</b> Low signal input.	<b>0.021</b> Apply a low reference signal to the meter.	<b>0.021</b> Press <b>▲</b> to store the low signal input in the meter.
<b>Hi In</b> High signal input.	<b>20.094</b> Apply a high reference signal to the meter.	<b>0.021</b> Press <b>▲</b> to store the high signal input in the meter.
<b>Lo rd</b> Desired reading at Lo In.	<b>0.0000</b> <b>0.0000</b> <b>0.0000</b> <b>0.0000</b> <b>0.0000</b> Select digit to flash.	<b>0.0000</b> Select <b>9</b> thru <b>9</b> for flashing first digit, <b>0</b> thru <b>9</b> for other flashing digits. Decimal point is set by <b>dEC.Pt.</b>
<b>Hi rd</b> Desired reading at Hi In.	<b>0.0000</b> <b>0.0000</b> <b>0.0000</b> <b>0.0000</b> <b>0.0000</b> Select digit to flash.	<b>6.7500</b> Select <b>9</b> thru <b>9</b> for flashing first digit, <b>0</b> thru <b>9</b> for other flashing digits. Decimal point is set by <b>dEC.Pt.</b>

Option board dependent menu items

**ALSEt** **ALS34** **dEU1H** **dEU2H** **dEU1b** **dEU2b** **dEU3H** **DEU4H** **DEU3b** **DEU4b**

Menu items related to **alarm setup**. These will only appear if a relay board is detected. If so, please see Section 16.

**AnSEt** **An Lo** **An Hi**

Menu items related to **analog output setup**. These will only appear if an analog output board is detected. If so, see Section 17.

**SER 1** **SER 2** **SER 3** **SER 4** **Addr**

Menu items related to **serial communications**. These will only appear if an RS232, RS485 or USB I/O board is detected. If so, see Section 18.

Menu lockout items

**Loc 1** **Loc 2** **Loc 3**

Menu items used to enable or lock out (hide) other menu items. **Loc** menu items may in turn be locked out by a hardware jumper. Please see Section 9.

- \* *Scaling method 2, "Reading Coordinates of 2 Points Scaling Method," will appear before all other Menu items, including **InPut**. Decimal point is set by **dEC.Pt**.*

## 12. LOAD CELL & MICROVOLT INPUT

The Load Cell and Microvolt meters utilize the load cell signal conditioner board, which offers sensitivity to  $\pm 20$  mV full scale and 4 or 6-wire load cell connection. This board needs to be configured via jumpers for the desired voltage range. All signal ranges are factory calibrated with calibration factors stored in EEPROM. The meter software recognizes the board and will bring up the appropriate menu items for it; however, it does not recognize the jumper settings. Please see further manual sections for setup of the following features: relay output (16), analog output (17), communications (18), and transducer excitation output (19).

### RANGE SELECTION VIA JUMPERS

**Ranges & Display with Scale Factor = 1**

Input	Jumpers	Full scale display
$\pm 20$ mV	e	$\pm 20000$
$\pm 50$ mV	a	$\pm 50000$
$\pm 100$ mV	b	$\pm 10000$
$\pm 250$ mV	c	$\pm 25000$
$\pm 500$ mV	d	$\pm 50000$

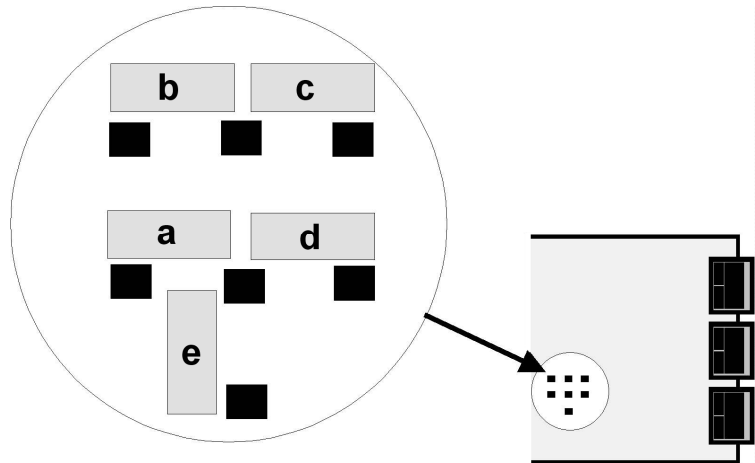

- Notes**
1. See Section 19 to select 10V excitation.
  2. Jumpers are 2.5 mm (0.1 in).



### SCALE & OFFSET SETUP



**For DC microvolt meters**, a scale factor of 1 and an offset of 0 are used for direct readings in microvolts or millivolts. Decimal point selection does not affect the displayed digits. For example, 20 mV can be displayed as 20.000 mV or 20000  $\mu$ V. The decimal point is set separately.



**For load cell applications**, scaling is normally set up from the front panel using the **▶** and **▲** keys, but can also be set up via RS232/485 using special PC-compatible setup software (available at no charge). The meter allows three scaling methods to be selected: 1) *Manual scale and offset*, 2) *Coordinates of 2 points*, and 3) *Reading coordinates of 2 points*. Please see the Glossary for an explanation of each method.

## KEYSTROKES FOR SETUP

If the **MENU**  key does not work, see Section 9 “Enabling & Locking Out Menu Items.”

 <b>MENU</b> Press Menu Select Key	 <b>PEAK</b> Press Digit Select Key	 <b>RESET</b> Press Value Select Key
<b>InPut</b> Selection of signal input type & range	<b>Strn</b> Strain or ratiometric	<b>20.0</b> <b>50.0</b> <b>100.0</b> <b>250.0</b> <b>500.0</b> 20, 50, 100, 250, 500 mV FS voltage
	<b>dC u</b> DC millivolts	<b>20.0</b> <b>50.0</b> <b>100.0</b> <b>250.0</b> <b>500.0</b> 20, 50, 100, 250, 500 mV FS voltage
<b>SEtUP</b> Meter Setup	<b>00_00</b> Display type	<b>0</b> 4-1/2 digit meter, counts by 1 <b>1</b> 5-digit remote display (±99,999) <b>2</b> 4-1/2 digit meter, counts by 10 <b>3</b> 3-1/2 digit meter
	<b>00_00</b> Power line frequency	<b>0</b> Noise minimized for 60 Hz <b>1</b> Noise minimized for 50 Hz
	<b>00_00</b> Scaling method	<b>0</b> Scale and offset method <b>1</b> Coordinates of 2 points method <b>2</b> Reading coordinates of 2 points method
	<b>00_00</b> Rear connector control inputs 1 & 2. <b>True</b> = logic 1 (0V or tied to digital ground) <b>False</b> = logic 0 (5V or open)	<b>0</b> 1 = Reset, 2 = Meter Hold <b>1</b> 1 = Function Reset 2 = Pk or Valley Disp. <b>2</b> 1 = Meter Hold 2 = Pk or Valley Disp. <b>3</b> 1 = Meter Hold 2 = Tare <b>4</b> 1 = Peak or Valley 2 = Tare <b>5</b> 1 = Tare 2 = Reset <b>6</b> 1 = 0, 2 = 0, decimal point 1 = XXXXX 1 = 1, 2 = 0, decimal point 1 = XXXX.X 1 = 0, 2 = 1, decimal point 1 = XXX.XX 1 = 1, 2 = 1, decimal point 1 = XX.XXX <b>7</b> 1 = 0, 2 = 0, decimal point 2 = XXXX.X 1 = 1, 2 = 0, decimal point 2 = XXX.XX 1 = 0, 2 = 1, decimal point 2 = XX.XXX 1 = 1, 2 = 1, decimal point 2 = X.XXXX <b>8</b> 1 = Function Reset 2 = Display Blank <b>9</b> 1 = Hold 2 = Display Blank <b>A</b> 1 = Peak or Valley 2 = Display Blank <b>B</b> 1 = Tare 2 = Display Blank <b>C</b> 1 = Valley Display 2 = Peak Display <b>D</b> 1 = Tare 2 = Tare Reset
		Both control inputs 1 & 2 set to 1 for selections <b>2, 4, A, C</b> = Function Reset. Both control inputs 1 & 2 set to 1 for selections <b>0, 1, 3, 5, 8, 9, B, D</b> = Meter Reset.

<b>MENU</b>  <b>Press Menu Select Key</b>	<b>PEAK</b>  <b>Press Digit Select Key</b>	<b>RESET</b>  <b>Press Value Select Key</b>
<b>ConFG</b> Meter Configuration	<b>000_0</b> Operation as a rate of change meter. <i>Extended meter only.</i>	<b>0</b> Not rate of change <b>1</b> Rate x 0.1 <b>2</b> Rate x 1 <b>3</b> Rate x 10 <b>4</b> Rate x 100 <b>5</b> Rate x 1000 <b>6</b> Rate x 10000
	<b>000_0</b> Operation of front panel <i>PEAK</i> button and rear connector for Peak or Valley Display	<b>0</b> Peak Display. Also selects “Peak” in “Peak or Valley” at connector above. <b>1</b> Valley Display. Also selects “Valley” in “Peak or Valley” at connector above. <b>2</b> Peak (1st push), Valley (2nd push) <b>3</b> Front panel Tare
	<b>000_0</b> Auto-tare	<b>0</b> Meter comes up in normal run mode. <b>1</b> Meter comes up in auto-tare mode
	<b>000_0</b> Nonlinear input scaling <i>Extended meter only.</i>	<b>0</b> Linear input <b>1</b> Custom curve linearization
<b>FiLtr</b> Filtering	<b>00000</b> Alarm filtering	<b>0</b> Unfiltered output <b>1</b> Filtered output
	<b>00000</b> Peak & Valley filtering	<b>0</b> Unfiltered Peak & Valley <b>1</b> Filtered Peak & Valley
	<b>00000</b> Display filtering	<b>0</b> Display batch average every 16 readings <b>1</b> Display filtered signal
	<b>00000</b> Adaptive filter threshold	<b>0</b> Low adaptive filter threshold level* <b>1</b> High adaptive filter threshold level
	<b>00000</b> Input signal filtering. <i>Can be applied to display, setpoint, analog output, data output.</i>	<b>0</b> Autofilter <b>1</b> Batch average, 16 readings <b>2</b> Moving average, 0.08 sec. <b>3</b> Moving average, 0.15 sec. <b>4</b> Moving average, 0.3 sec. <b>5</b> Moving average, 0.6 sec. <b>6</b> Moving average, 1.2 sec. <b>7</b> Moving average, 2.4 sec. <b>8</b> Moving average, 4.8 sec. <b>9</b> Moving average, 9.6 sec. <b>A</b> Unfiltered
<b>dEc.Pt</b> Dec. point selection	<b>d_ddd</b> Decimal point flashes.	<b>d_ddd</b> <b>dd_ddd</b> <b>ddd_dd</b> <b>dddd_d</b> <b>dddd.</b> <b>_dddd</b>

 <b>MENU</b> Press Menu Select Key	 <b>PEAK</b> Press Digit Select Key	 <b>RESET</b> Press Value Select Key
Scaling method "Scale and Offset" if selected under <b>SEtuP</b>		
<b>SCALE</b> Scale factor	<b>0.0000</b> <b>0.0000</b> <b>0.0000</b> <b>0.0000</b> <b>0.0000</b> <b>0.0000</b> Select digit to flash.	Select <b>9</b> thru <b>9</b> for flashing first digit, <b>0</b> thru <b>9</b> for other flashing digits. Select decimal point location when decimal point is flashing.
<b>OFFst</b> Offset value	<b>0.0000</b> <b>0.0000</b> <b>0.0000</b> <b>0.0000</b> <b>0.0000</b> Select digit to flash.	Select <b>9</b> thru <b>9</b> for flashing first digit, <b>0</b> thru <b>9</b> for other flashing digits. Decimal point location is selected by <b>dEC.Pt.</b>
Scaling method "Coordinates of 2 points" if selected under <b>SEtuP</b>		
<b>Lo In</b> Low signal input.	<b>0.0000</b> <b>0.0000</b> <b>0.0000</b> <b>0.0000</b> <b>0.0000</b> Select digit to flash.	Select <b>9</b> thru <b>9</b> for flashing first digit, <b>0</b> thru <b>9</b> for other flashing digits. Decimal point is set by input range chosen.
<b>Lo rd</b> Desired reading at Lo In.	<b>0.0000</b> <b>0.0000</b> <b>0.0000</b> <b>0.0000</b> <b>0.0000</b> Select digit to flash.	Select <b>9</b> thru <b>9</b> for flashing first digit, <b>0</b> thru <b>9</b> for other flashing digits. Decimal point is set by <b>dEC.Pt.</b>
<b>Hi In</b> High signal input.	<b>0.0000</b> <b>0.0000</b> <b>0.0000</b> <b>0.0000</b> <b>0.0000</b> Select digit to flash.	Select <b>9</b> thru <b>9</b> for flashing first digit, <b>0</b> thru <b>9</b> for other flashing digits. Decimal point is set by input range chosen.
<b>Hi rd</b> Desired reading at Hi In.	<b>0.0000</b> <b>0.0000</b> <b>0.0000</b> <b>0.0000</b> <b>0.0000</b> Select digit to flash.	Select <b>9</b> thru <b>9</b> for flashing first digit, <b>0</b> thru <b>9</b> for other flashing digits. Decimal point is set by <b>dEC.Pt.</b>
Scaling method "Reading coordinates of 2 points" if selected under <b>SEtuP</b>		
<b>Lo In</b> Low signal input.	<b>0.021</b> Apply a low reference signal to the meter.	<b>0.021</b> Press <b>▲</b> to store the low signal input in the meter.
<b>Hi In</b> High signal input.	<b>20.094</b> Apply a high reference signal to the meter.	<b>20.094</b> Press <b>▲</b> to store the high signal input in the meter.
<b>Lo rd</b> Desired reading at Lo In.	<b>0.0000</b> <b>0.0000</b> <b>0.0000</b> <b>0.0000</b> <b>0.0000</b> Select digit to flash.	<b>0.0000</b> Select <b>9</b> thru <b>9</b> for flashing first digit, <b>0</b> thru <b>9</b> for other flashing digits. Decimal point is set by <b>dEC.Pt.</b>
<b>Hi rd</b> Desired reading at Hi In.	<b>0.0000</b> <b>0.0000</b> <b>0.0000</b> <b>0.0000</b> <b>0.0000</b> Select digit to flash.	<b>6.7500</b> Select <b>9</b> thru <b>9</b> for flashing first digit, <b>0</b> thru <b>9</b> for other flashing digits. Decimal point is set by <b>dEC.Pt.</b>

Option board dependent menu items

**ALSEt** **ALS34** **dEU1H** **dEU2H** **dEU1b** **dEU2b** **dEU3H** **DEU4H** **DEU3b** **DEU4b**

Menu items related to **alarm setup**. These will only appear if a relay board is detected. If so, please see Section 16.

**AnSEt** **An Lo** **An Hi**

Menu items related to **analog output setup**. These will only appear if an analog output board is detected. If so, see Section 17.

**SER 1** **SER 2** **SER 3** **SER 4** **Addr**

Menu items related to **serial communications**. These will only appear if an RS232, RS485 or USB I/O board is detected. If so, see Section 18.

Menu lockout items

**Loc 1** **Loc 2** **Loc 3**

Menu items used to enable or lock out (hide) other menu items. **Loc** menu items may in turn be locked out by a hardware jumper. Please see Section 9.



## 13. AC TRUE RMS VOLTS & AMPS INPUT

AC voltage or current measurement utilizes the True RMS signal conditioner board which uses precision circuitry to compute the root-mean-square of complex waveforms from 10 Hz to 10 kHz. Accurate measurements are obtained with spikes up to 3 times the maximum of each range. The input can be AC coupled to read only the AC component, such as ripple on a power supply, or DC coupled to read AC plus DC. The board needs to be configured via jumpers for the desired voltage or current range, and for AC or DC coupling. All signal ranges are factory calibrated with calibration factors stored in EEPROM.

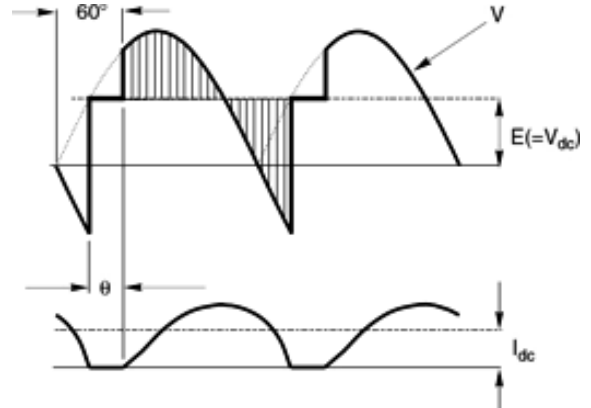

The meter software recognizes the board and will bring up the appropriate menu items for it; however, it does not recognize the jumper settings. These need to be set manually. Please see further manual sections for setup of the following features: relay output (16), analog output (17), and communications (18).

### Voltage Ranges

Full Scale Input	Counts	Jumpers
200 mV	20000	j
2V	20000	c, g, h
20V	20000	c, i
200V	20000	c, k
300V (UL)	3000	c, m
600V (not UL)	6000	c, m

### Current Ranges

Full Scale Input	Counts	Jumpers
2 mA	20000	l, k
20 mA	20000	b, m
200 mA	20000	a, m
5A	5000	c, d, e, m

### AC or DC Coupling

Coupling Type	Jumpers
DC coupling for AC + DC	f
AC coupling for AC only	none

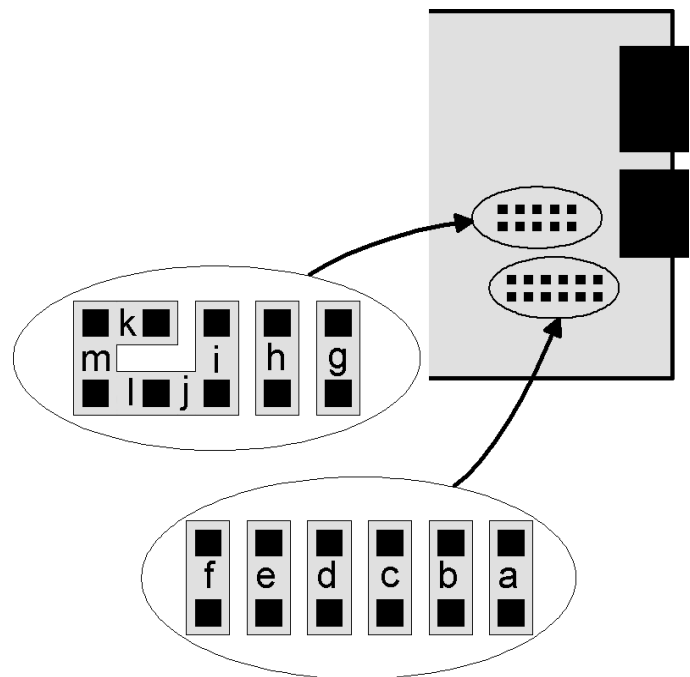

### RANGE SELECTION VIA JUMPERS

1. Letters indicate jumper position. Jumpers are installed on pins adjacent to letters.
2. Use 2.5 mm (0.1") jumpers.
3. Store spare jumpers on unused jumper post.

### METER SCALING

Refer to the above tables for the full scale counts (or displayed digits) produced by the available full scale input ranges with a scale factor of 1 and an offset of 0. The decimal point

can be set for direct readout in (milli)volts or (milli)amperes. Decimal point selection does not affect the counts. For example, a 20V input may be displayed as 20.000V or 20000 mV.

The 5A range, designed for use with a 5A current transformer (CT), is scaled to produce 5000 counts with a scale factor of 1 and an offset of 0. Use with a specific CT will require the scale factor to be set. For example, for an 800A input, 5A output CT, set a scale factor of 1.6. This is the desired 8000 count display at 5A divided by the default 5000 count display at 5A. Then set the decimal point to display to 800.0 at 5A.

All scaling methods applicable to DC, process, strain and load cell meters are available with AC RMS meters.

### INTERNAL SHIELD

To reduce noise pickup inside the meter or transmitter, the RMS board is fitted with a flexible plug-on shield. If necessary, This shield may be removed for jumper setting, but must be reinstalled before closing the instrument.

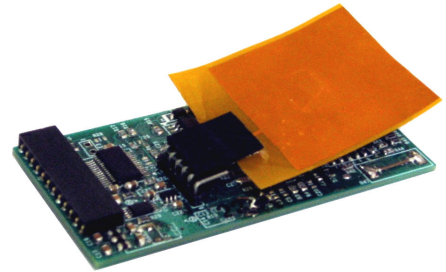

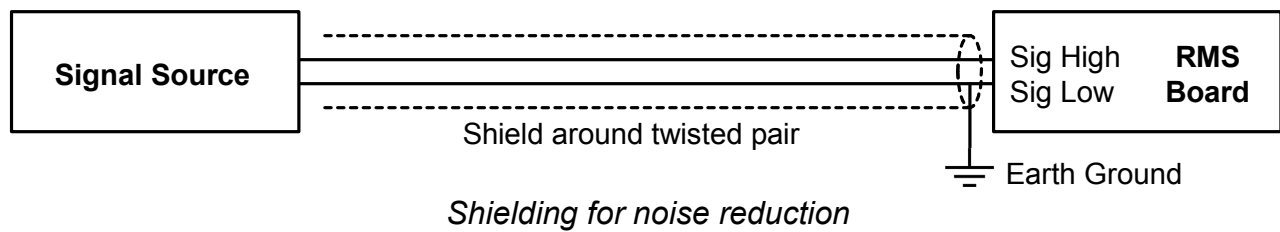

### SIGNAL SHIELDING









AC RMS measurements are susceptible to signal noise. This is especially true when the instrument has a wide bandwidth. To minimize noise pickup, the input signal wiring should utilize a shielded twisted pair, and the shield should be connected to signal low at the meter, as illustrated. If signal low is close to earth ground, such as within 2V, signal low can further be connected to earth ground at the meter, as illustrated.

## KEYSTROKES FOR SETUP

If the **MENU**  key does not work, see Section 9 “Enabling & Locking Out Menu Items.”

<b>MENU</b>  <b>Press Menu Select Key</b>	<b>PEAK</b>  <b>Press Digit Select Key</b>	<b>RESET</b>  <b>Press Value Select Key</b>
<b>InPut</b> Selection of signal input type & range	<b>AC U</b> AC Volts	<b>0.2U</b> <b>2.0U</b> <b>20.0U</b> <b>200.0U</b> <b>600.0U</b> 0.2, 2, 20, 200, 660V FS
	<b>AC A</b> AC Amps	<b>2.0a</b> <b>20.0a</b> <b>200.0a</b> <b>5.0A</b> 2, 20, 200 mA, 5A FS
<b>SEtUP</b> Meter Setup	<b>00_00</b> Display selection with scale factor of 1	<b>0</b> 4-1/2 digits (±20,000) <b>1</b> Remote display (±99,999) <b>2</b> 4-1/2 digits, counts by 10 (±20,000) <b>3</b> 3-1/2 digits (±2,000)
	<b>00_00</b> Power line frequency	<b>0</b> Noise minimized for 60 Hz <b>1</b> Noise minimized for 50 Hz
	<b>00_00</b> Scaling method	<b>0</b> Scale and offset method <b>1</b> Coordinates of 2 points method <b>2</b> Reading coordinates of 2 points method
	<b>00_00</b> Rear connector inputs 1 & 2 <b>True</b> = logic 1 (0V or tied to digital ground) <b>False</b> = logic 0 (5V or open)	<b>0</b> 1 = Reset, 2 = Meter Hold <b>1</b> 1 = Function Reset 2 = Pk or Valley Disp. <b>2</b> 1 = Meter Hold 2 = Pk or Valley Disp. <b>3</b> 1 = Meter Hold 2 = Tare <b>4</b> 1 = Peak or Valley 2 = Tare <b>5</b> 1 = Tare 2 = Reset <b>6</b> 1 = 0, 2 = 0, decimal point 1 = XXXXX 1 = 1, 2 = 0, decimal point 1 = XXXX.X 1 = 0, 2 = 1, decimal point 1 = XXX.XX 1 = 1, 2 = 1, decimal point 1 = XX.XXX <b>7</b> 1 = 0, 2 = 0, decimal point 2 = XXXX.X 1 = 1, 2 = 0, decimal point 2 = XXX.XX 1 = 0, 2 = 1, decimal point 2 = XX.XXX 1 = 1, 2 = 1, decimal point 2 = X.XXXX <b>8</b> 1 = Function Reset 2 = Display Blank <b>9</b> 1 = Hold 2 = Display Blank <b>A</b> 1 = Peak or Valley 2 = Display Blank <b>B</b> 1 = Tare 2 = Display Blank <b>C</b> 1 = Valley Display 2 = Peak Display <b>D</b> 1 = Tare 2 = Tare Reset
		Both control inputs 1 & 2 set to 1 for selections <b>2, 4, A, C</b> = Function Reset. Both control inputs 1 & 2 set to 1 for selections <b>0, 1, 3, 5, 8, 9, B, D</b> = Meter Reset.

 <b>Press Menu Select Key</b>	 <b>Press Digit Select Key</b>	 <b>Press Value Select Key</b>
<b>ConFG</b> Meter Configuration	<b>000_0</b> Operation as a <i>rate of change meter</i> . <i>Extended meter only.</i>	<b>0</b> Not rate of change <b>1</b> Rate x 0.1 <b>2</b> Rate x 1 <b>3</b> Rate x 10 <b>4</b> Rate x 100 <b>5</b> Rate x 1000 <b>6</b> Rate x 10000
	<b>00__0</b> Operation of front panel <i>PEAK</i> button and rear connector for Peak or Valley Display	<b>0</b> Peak Display. Also selects “Peak” in “Peak or Valley” at connector above. <b>1</b> Valley Display. Also selects “Valley” in “Peak or Valley” at connector above. <b>2</b> Peak (1st push), Valley (2nd push) <b>3</b> Front panel Tare
	<b>000_0</b> Auto-tare	<b>0</b> Meter comes up in normal run mode. <b>1</b> Meter comes up in auto-tare mode
	<b>000_0</b> Nonlinear input scaling <i>Extended meter only.</i>	<b>0</b> Linear input <b>1</b> Custom curve linearization
<b>FiLtr</b> Filtering	<b>00000</b> Alarm filtering	<b>0</b> Unfiltered output <b>1</b> Filtered output
	<b>00000</b> Peak & Valley filtering	<b>0</b> Unfiltered Peak & Valley <b>1</b> Filtered Peak & Valley
	<b>00000</b> Display filtering	<b>0</b> Display batch average every readings <b>1</b> Display filtered signal
	<b>00000</b> Filtering for AC signal	<b>0</b> Non-adaptive moving average filter <b>1</b> High-threshold adaptive moving avg filter
	<b>00000</b> Input signal filtering. <i>Can be applied to display, setpoint, analog output, data output.</i>	<b>0</b> Autofilter <b>1</b> Batch average, 16 readings <b>2</b> Moving average, 0.08 sec. <b>3</b> Moving average, 0.15 sec. <b>4</b> Moving average, 0.3 sec. <b>5</b> Moving average, 0.6 sec. <b>6</b> Moving average, 1.2 sec. <b>7</b> Moving average, 2.4 sec. <b>8</b> Moving average, 4.8 sec. <b>9</b> Moving average, 9.6 sec. <b>A</b> Unfiltered
<b>dEc.Pt</b> Dec. point selection	<b>d_ddd</b> Decimal point flashes.	<b>d_ddd</b> <b>dd_ddd</b> <b>ddd_dd</b> <b>dddd_d</b> <b>dddd_</b> <b>_dddd</b>

 <b>MENU</b> Press Menu Select Key	 <b>PEAK</b> Press Digit Select Key	 <b>RESET</b> Press Value Select Key
Scaling method "Scale and Offset" if selected under <b>SEtuP</b>		
<b>SCALE</b> Scale factor	<b>0.0000</b> <b>0.0000</b> <b>0.0000</b> <b>0.0000</b> <b>0.0000</b> <b>0.0000</b> Select digit to flash.	Select <b>9</b> thru <b>9</b> for flashing first digit, <b>0</b> thru <b>9</b> for other flashing digits. Select decimal point location when decimal point is flashing.
<b>OFFst</b> Offset value	<b>0.0000</b> <b>0.0000</b> <b>0.0000</b> <b>0.0000</b> <b>0.0000</b> Select digit to flash.	Select <b>9</b> thru <b>9</b> for flashing first digit, <b>0</b> thru <b>9</b> for other flashing digits. Decimal point location is selected by <b>dEC.Pt.</b>
Scaling method "Coordinates of 2 points" if selected under <b>SEtuP</b>		
<b>Lo In</b> Low signal input.	<b>0.0000</b> <b>0.0000</b> <b>0.0000</b> <b>0.0000</b> <b>0.0000</b> Select digit to flash.	Select <b>9</b> thru <b>9</b> for flashing first digit, <b>0</b> thru <b>9</b> for other flashing digits. Decimal point is set by input range chosen.
<b>Lo rd</b> Desired reading at Lo In.	<b>0.0000</b> <b>0.0000</b> <b>0.0000</b> <b>0.0000</b> <b>0.0000</b> Select digit to flash.	Select <b>9</b> thru <b>9</b> for flashing first digit, <b>0</b> thru <b>9</b> for other flashing digits. Decimal point is set by <b>dEC.Pt.</b>
<b>Hi In</b> High signal input.	<b>0.0000</b> <b>0.0000</b> <b>0.0000</b> <b>0.0000</b> <b>0.0000</b> Select digit to flash.	Select <b>9</b> thru <b>9</b> for flashing first digit, <b>0</b> thru <b>9</b> for other flashing digits. Decimal point is set by input range chosen.
<b>Hi rd</b> Desired reading at Hi In.	<b>0.0000</b> <b>0.0000</b> <b>0.0000</b> <b>0.0000</b> <b>0.0000</b> Select digit to flash.	Select <b>9</b> thru <b>9</b> for flashing first digit, <b>0</b> thru <b>9</b> for other flashing digits. Decimal point is set by <b>dEC.Pt.</b>
Scaling method "Reading coordinates of 2 points" if selected under <b>SEtuP</b>		
<b>Lo In</b> Low signal input.	<b>0.021</b> Apply a low reference signal to the meter.	<b>0.021</b> Press <b>▲</b> to store the low signal input in the meter.
<b>Hi In</b> High signal input.	<b>20.094</b> Apply a high reference signal to the meter.	<b>0.021</b> Press <b>▲</b> to store the high signal input in the meter.
<b>Lo rd</b> Desired reading at Lo In.	<b>0.0000</b> <b>0.0000</b> <b>0.0000</b> <b>0.0000</b> <b>0.0000</b> Select digit to flash.	<b>0.0000</b> Select <b>9</b> thru <b>9</b> for flashing first digit, <b>0</b> thru <b>9</b> for other flashing digits. Decimal point is set by <b>dEC.Pt.</b>
<b>Hi rd</b> Desired reading at Hi In.	<b>0.0000</b> <b>0.0000</b> <b>0.0000</b> <b>0.0000</b> <b>0.0000</b> Select digit to flash.	<b>6.7500</b> Select <b>9</b> thru <b>9</b> for flashing first digit, <b>0</b> thru <b>9</b> for other flashing digits. Decimal point is set by <b>dEC.Pt.</b>

Option board dependent menu items

**ALSEt** **ALS34** **dEU1H** **dEU2H** **dEU1b** **dEU2b** **dEU3H** **DEU4H** **DEU3b** **DEU4b**

Menu items related to **alarm setup**. These will only appear if a relay board is detected. If so, please see Section 16.

**AnSEt** **An Lo** **An Hi**

Menu items related to **analog output setup**. These will only appear if an analog output board is detected. If so, see Section 17.

**SER 1** **SER 2** **SER 3** **SER 4** **Addr**

Menu items related to **serial communications**. These will only appear if an RS232, RS485 or USB I/O board is detected. If so, see Section 18.

Menu lockout items

**Loc 1** **Loc 2** **Loc 3**

Menu items used to enable or lock out (hide) other menu items. **Loc** menu items may in turn be locked out by a hardware jumper. Please see Section 9.

- \* *Scaling method 2, "Reading Coordinates of 2 Points Scaling Method," will appear before all other Menu items, including **InPut**. Decimal point is set by **dEC.Pt**.*

## 14. THERMOCOUPLE INPUT

The thermocouple signal conditioner board used for temperature measurement can be configured via jumpers for 7 thermocouple types, each in a single range: J, K, T, E, N, S, R. The meter software recognizes the board and will bring up the appropriate menu items for it; however, it does not recognize the jumper settings. Display in °C or °F and resolution of 1°, 0.1° or 0.01° are user programmable. High resolution should only be used for relative readings, not absolute readings. Although available, 0.01° resolution is not recommended for thermocouples. Offset adjustment is available for thermocouples and is normally set to 0000.0. If °C is selected, entering an offset of 0273.2 will change the display to Kelvin. If °F is selected, entering an offset of 0459.7 will change the display to Rankin.

The addition of a relay output board turns the thermocouple meter from a temperature indicator into an on/off temperature controller. Please see further manual sections for setup of the following features: relay output (Section 16), analog output (17), and communications (18).

### SIGNAL CONDITIONER BOARD SETUP VIA JUMPERS

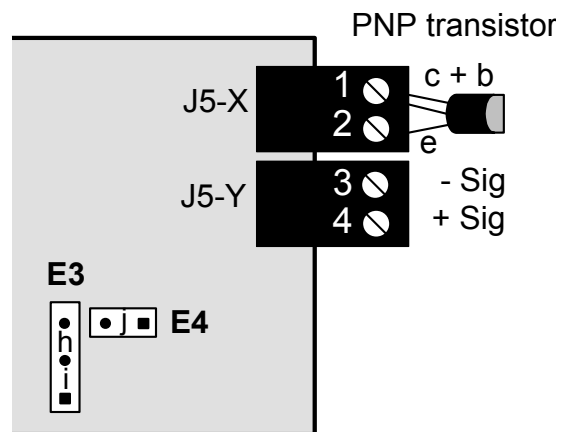

Type	E4 Jumper
J, K, E, N T, R, S	none j
Open Indication	E3 Jumper
Upscale Downscale	h i





1. Letters indicate jumper position.
2. Jumpers are installed on pins adjacent to letters.
3. Use 2.5 mm (0.1") jumpers.
4. Store spare jumpers on an unused jumper post.

## KEYSTROKES FOR SETUP

If the **MENU**  key does not work, see Section 9 “Enabling & Locking Out Menu Items.”

 <b>MENU</b> Press Menu Select Key	 <b>PEAK</b> Press Digit Select Key	 <b>RESET</b> Press Value Select Key																											
<b>InPut</b> Selection of signal input type & range	<b>tC</b> Thermocouple	<table border="0"> <tr> <td><b>J °F</b></td> <td><b>J °C</b></td> <td>Type J, °F or °C</td> </tr> <tr> <td><b>K °F</b></td> <td><b>K °C</b></td> <td>Type K, °F or °C</td> </tr> <tr> <td><b>n °F</b></td> <td><b>n °C</b></td> <td>Type N, °F or °C</td> </tr> <tr> <td><b>E °F</b></td> <td><b>E °C</b></td> <td>Type E, °F or °C</td> </tr> <tr> <td><b>t °F</b></td> <td><b>t °C</b></td> <td>Type T, °F or °C</td> </tr> <tr> <td><b>S °F</b></td> <td><b>S °C</b></td> <td>Type S, °F or °C</td> </tr> <tr> <td><b>r °F</b></td> <td><b>r °C</b></td> <td>Type R, °F or °C</td> </tr> </table>	<b>J °F</b>	<b>J °C</b>	Type J, °F or °C	<b>K °F</b>	<b>K °C</b>	Type K, °F or °C	<b>n °F</b>	<b>n °C</b>	Type N, °F or °C	<b>E °F</b>	<b>E °C</b>	Type E, °F or °C	<b>t °F</b>	<b>t °C</b>	Type T, °F or °C	<b>S °F</b>	<b>S °C</b>	Type S, °F or °C	<b>r °F</b>	<b>r °C</b>	Type R, °F or °C						
<b>J °F</b>	<b>J °C</b>	Type J, °F or °C																											
<b>K °F</b>	<b>K °C</b>	Type K, °F or °C																											
<b>n °F</b>	<b>n °C</b>	Type N, °F or °C																											
<b>E °F</b>	<b>E °C</b>	Type E, °F or °C																											
<b>t °F</b>	<b>t °C</b>	Type T, °F or °C																											
<b>S °F</b>	<b>S °C</b>	Type S, °F or °C																											
<b>r °F</b>	<b>r °C</b>	Type R, °F or °C																											
<b>SEtuP</b> Meter Setup	<b>00_00</b> Display selection.	<b>0</b> 0.1 degree resolution <b>1</b> Remote display (±99,999) <b>2</b> 0.01 degree resolution <b>3</b> 1 degree resolution																											
	<b>00_00</b> Power line frequency	<b>0</b> Noise minimized for 60 Hz <b>1</b> Noise minimized for 50 Hz																											
	<b>00_00</b> Scaling method	<b>0</b> Offset only for thermocouple input.																											
	<b>00_00</b> control inputs 1 & 2: <b>True</b> = logic 1 (0V or tied to digital ground) <b>False</b> = logic 0 (5V or open)	<table border="0"> <tr> <td><b>0</b></td> <td>1 = Reset, 2 = Meter Hold</td> </tr> <tr> <td><b>1</b></td> <td>1 = Function Reset, 2 = Peak or Valley</td> </tr> <tr> <td><b>2</b></td> <td>1 = Hold, 2 = Peak or Valley Display</td> </tr> <tr> <td><b>3</b></td> <td>1 = Hold, 2 = Tare</td> </tr> <tr> <td><b>4</b></td> <td>1 = Peak or Valley Display, 2 = Tare</td> </tr> <tr> <td><b>5</b></td> <td>1 = Tare, 2 = Reset</td> </tr> <tr> <td><b>6</b></td> <td>1 = 0, 2 = 0, decimal point 1 = XXXXX            1 = 1, 2 = 0, decimal point 1 = XXXX.X            1 = 0, 2 = 1, decimal point 1 = XXX.XX            1 = 1, 2 = 1, decimal point 1 = XX.XXX</td> </tr> <tr> <td><b>7</b></td> <td>1 = 0, 2 = 0, decimal point 2 = XXXX.X            1 = 1, 2 = 0, decimal point 2 = XXX.XX            1 = 0, 2 = 1, decimal point 2 = XX.XXX            1 = 1, 2 = 1, decimal point 2 = X.XXXX</td> </tr> <tr> <td><b>8</b></td> <td>1 = Function Reset 2 = Display Blank</td> </tr> <tr> <td><b>9</b></td> <td>1 = Hold 2 = Display Blank</td> </tr> <tr> <td><b>A</b></td> <td>1 = Peak or Valley 2 = Display Blank</td> </tr> <tr> <td><b>B</b></td> <td>1 = Tare 2 = Display Blank</td> </tr> <tr> <td><b>C</b></td> <td>1 = Valley Display 2 = Peak Display</td> </tr> <tr> <td><b>D</b></td> <td>1 = Tare 2 = Tare Reset</td> </tr> </table> <p>Both control inputs 1 &amp; 2 set to 1 for selections <b>2, 4, A, C</b> = Function Reset.            Both control inputs 1 &amp; 2 set to 1 for selections <b>0, 1, 3, 5, 8, 9, B, D</b> = Meter Reset.</p>	<b>0</b>	1 = Reset, 2 = Meter Hold	<b>1</b>	1 = Function Reset, 2 = Peak or Valley	<b>2</b>	1 = Hold, 2 = Peak or Valley Display	<b>3</b>	1 = Hold, 2 = Tare	<b>4</b>	1 = Peak or Valley Display, 2 = Tare	<b>5</b>	1 = Tare, 2 = Reset	<b>6</b>	1 = 0, 2 = 0, decimal point 1 = XXXXX 1 = 1, 2 = 0, decimal point 1 = XXXX.X 1 = 0, 2 = 1, decimal point 1 = XXX.XX 1 = 1, 2 = 1, decimal point 1 = XX.XXX	<b>7</b>	1 = 0, 2 = 0, decimal point 2 = XXXX.X 1 = 1, 2 = 0, decimal point 2 = XXX.XX 1 = 0, 2 = 1, decimal point 2 = XX.XXX 1 = 1, 2 = 1, decimal point 2 = X.XXXX	<b>8</b>	1 = Function Reset 2 = Display Blank	<b>9</b>	1 = Hold 2 = Display Blank	<b>A</b>	1 = Peak or Valley 2 = Display Blank	<b>B</b>	1 = Tare 2 = Display Blank	<b>C</b>	1 = Valley Display 2 = Peak Display	<b>D</b>
<b>0</b>	1 = Reset, 2 = Meter Hold																												
<b>1</b>	1 = Function Reset, 2 = Peak or Valley																												
<b>2</b>	1 = Hold, 2 = Peak or Valley Display																												
<b>3</b>	1 = Hold, 2 = Tare																												
<b>4</b>	1 = Peak or Valley Display, 2 = Tare																												
<b>5</b>	1 = Tare, 2 = Reset																												
<b>6</b>	1 = 0, 2 = 0, decimal point 1 = XXXXX 1 = 1, 2 = 0, decimal point 1 = XXXX.X 1 = 0, 2 = 1, decimal point 1 = XXX.XX 1 = 1, 2 = 1, decimal point 1 = XX.XXX																												
<b>7</b>	1 = 0, 2 = 0, decimal point 2 = XXXX.X 1 = 1, 2 = 0, decimal point 2 = XXX.XX 1 = 0, 2 = 1, decimal point 2 = XX.XXX 1 = 1, 2 = 1, decimal point 2 = X.XXXX																												
<b>8</b>	1 = Function Reset 2 = Display Blank																												
<b>9</b>	1 = Hold 2 = Display Blank																												
<b>A</b>	1 = Peak or Valley 2 = Display Blank																												
<b>B</b>	1 = Tare 2 = Display Blank																												
<b>C</b>	1 = Valley Display 2 = Peak Display																												
<b>D</b>	1 = Tare 2 = Tare Reset																												



 <b>Press Menu Select Key</b>	 <b>Press Digit Select Key</b>	 <b>Press Value Select Key</b>
<b>ConFG</b> Meter Configuration	<b>000_0</b>	<b>0</b> No used.
	<b>00__0</b> Operation of front panel <b>PEAK</b> button and rear connector for Peak or Valley Display	<b>0</b> Peak Display. Also selects “Peak” in “Peak or Valley” at rear connector. <b>1</b> Valley Display. Also selects “Valley” in “Peak or Valley” at rear connector. <b>2</b> Peak (1st push), Valley (2nd push) <b>3</b> Front panel Tare
<b>FiLtr</b> Filtering	<b>00000</b> Alarm filtering	<b>0</b> Unfiltered output <b>1</b> Filtered output
	<b>00000</b> Peak & Valley filtering	<b>0</b> Unfiltered Peak & Valley <b>1</b> Filtered Peak & Valley
	<b>00000</b> Display filtering	<b>0</b> Display batch average every 16 readings <b>1</b> Display filtered signal
	<b>00000</b> Adaptive filter threshold	<b>0</b> Low adaptive filter threshold level <b>1</b> High adaptive filter threshold level
	<b>00000</b> Input signal filtering. <i>Can be applied to display, setpoint, analog output, data output.</i>	<b>0</b> Autofilter <b>1</b> Batch average, 16 readings <b>2</b> Moving average, 0.08 sec. <b>3</b> Moving average, 0.15 sec. <b>4</b> Moving average, 0.3 sec. <b>5</b> Moving average, 0.6 sec. <b>6</b> Moving average, 1.2 sec. <b>7</b> Moving average, 2.4 sec. <b>8</b> Moving average, 4.8 sec. <b>9</b> Moving average, 9.6 sec. <b>A</b> Unfiltered
<b>OFFst</b> Offset value	<b>0.0000 0.0000 0.0000</b> <b>0.0000 0.0000</b> Select digit to flash.	Select <b>9</b> thru <b>9</b> for flashing first digit, <b>0</b> thru <b>9</b> for other flashing digits. Use offset for display in Rankine or Kelvin.
Option board dependent menu items		
<b>ALSEt ALS34 dEU1H dEU2H dEU1b dEU2b dEU3H DEU4H DEU3b DEU4b</b> Menu items related to <b>alarm setup</b> if a relay board is detected. Please see Section 16.		
<b>AnSEt An Lo An Hi</b> Menu items related to <b>analog output</b> if detected. Please see Section 17.		
<b>SER 1 SER 2 SER 3 SER 4 Addr</b> Menu items related to <b>serial communications</b> if detected. Please see Section 18.		
Menu lockout items		
<b>Loc 1 Loc 2 Loc 3</b> Menu items used to enable or lock out (hide) menu items. Please see Section 9.		

## 15. RTD & RESISTANCE INPUT

The standard RTD and resistance signal conditioner board can be configured via jumpers for four RTD types (DIN 100Ω platinum, ANSI 100Ω platinum, 120Ω nickel, 10Ω copper) or five resistance ranges (from 20.000Ω to 200.00 kΩ). A fixed 2 MΩ resistance range (R6 ordering option) is provided by a factory modified signal conditioner board with component changes.

All ranges are factory calibrated with calibration factors stored in EEPROM on the signal conditioner board. The meter software recognizes the board and will bring up the appropriate menu items for it; however, it does not recognize the jumper settings. With RTDs, display in °C or °F and resolution of 1°, 0.1° or 0.01° are user programmable.

### SIGNAL CONDITIONER BOARD SETUP VIA JUMPERS

Standard Board	Modified Board	E1 Jumper
Pt100, Ni120	N/A	a
Cu10, 20.000Ω	N/A	b
0 - 200.00Ω	N/A	c
0 - 2.0000 kΩ	N/A	d
0 - 20.000 kΩ	N/A	e
0 - 200.00 kΩ	0 - 2.0000 MΩ	f
Connection		E2 Jumper
2 or 4 wire		none
3 wire		g

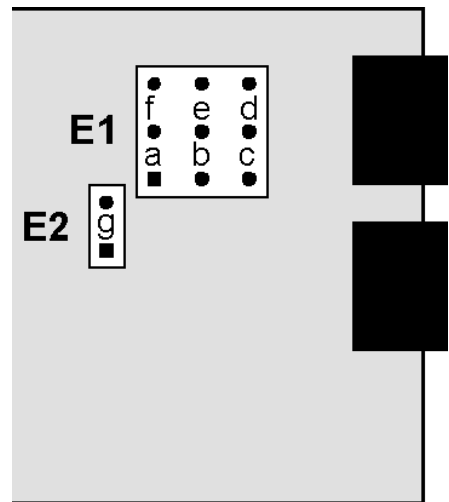

1. Program decimal point selection under **dEc.Pt** menu item.
2. Letters indicate jumper position. Jumpers are installed on pins adjacent to letters.
3. Store spare jumpers on an unused jumper post.

### SCALE & OFFSET SETUP

**Scale** is normally set to 1.0000. Scale can be used as an RTD correction when actual resistance is other than nominal, as stated on the RTD calibration sheet. For a Pt100 RTD, divide 100 by the stated resistance at 0°C. For example, for a 99.04 ohm RTD, scale should be set to  $100 / 99.04 = 1.0097$ .

### SIGNAL SHIELDING

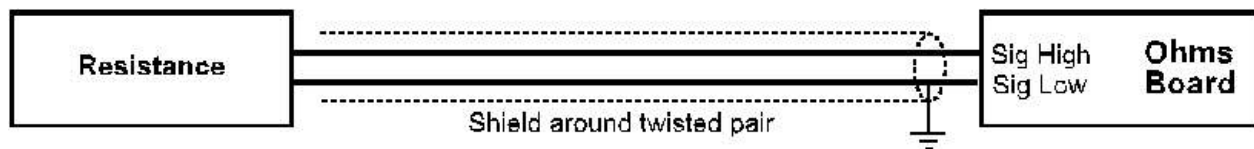

200 kΩ ranges and above measurements are susceptible to signal noise. To minimize noise pickup, the input signal wiring should utilize a shielded twisted pair and the shield should be connected to signal low and earth ground at the meter, as illustrated. Use 2-wire hookup.

## RTD & RESISTANCE CONNECTION

With the appropriate jumper settings, RTD and resistance measurements allow 2, 3 or 4-wire RTD hookup to the J5 connector, as illustrated. The meter applies a fixed excitation current.

**In 4-wire hookup**, lead resistance is not a factor, since different pairs of wires are used for excitation and sensing.

**In 3-wire hookup**, the meter automatically compensates for lead resistance by measuring the voltage drop in one current-carrying lead and assuming that the voltage drop in the other current-carrying lead is the same.

**In 2-wire hookup**, the meter senses the voltage drop across the load and both lead wires. The effect of the lead wires can be measured and subtracted by shorting out the load during meter setup. The short should be as close as possible to the load. Ambient temperature changes will still cause some error in the readings -- the higher the lead resistance, the greater the error.

To eliminate lead wire resistance, follow this procedure:



1. Set the InPut menu item and jumpers for the desired range
2. Set COnFG to **00011**.
3. Short the two leads at the sensor end.
4. When the display has settled, push the ► key. The meter will then store a value proportional to lead resistance, automatically change COnFG to **00010**, and then reset. The same result is obtained by grounding a Control Input that has been selected for Peak or Valley (SEtuP **00\_0Y**, where Y = 1, 2, 4, A, C ).
5. Remove the short and connect the sensor. The meter now processes the sensor resistance only.

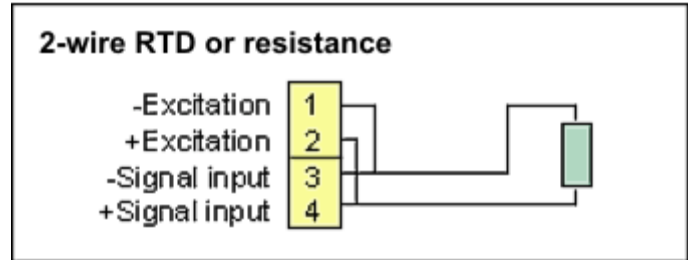
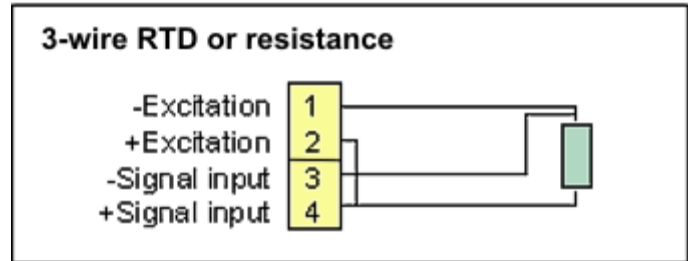
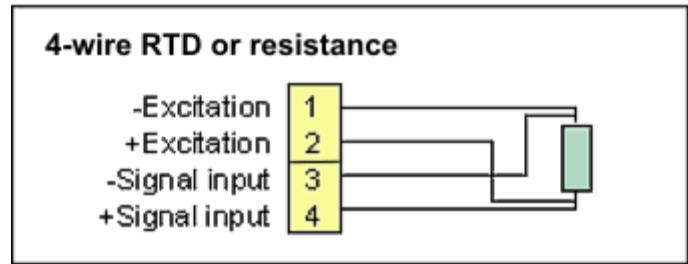

If the range and associated jumpers are subsequently changed, the above procedure must be repeated. This procedure is also available through Instrument Setup software, Revision 2.7.0 or later.



## KEYSTROKES FOR SETUP

If the *MENU*  key does not work, see Section 9 “Enabling & Locking Out Menu Items.”

 <b>MENU</b> Press Menu Select Key	 <b>PEAK</b> Press Digit Select Key	 <b>RESET</b> Press Value Select Key
<b>InPut</b> Selection of signal input type & range	<b>rtd</b> RTD	<b>d °F</b> Pt100 RTD, DIN alpha .00385, °F <b>d °C</b> Pt100 RTD, DIN alpha .00385, °C <b>A °F</b> Pt100 RTD, ANSI alpha .003902, °F <b>A °C</b> Pt100 RTD, ANSI alpha .003902, °C <b>ni °F</b> Ni120 RTD, alpha .00672, °F <b>ni °C</b> Ni120 RTD, alpha .00672, °C <b>Cu °F</b> Cu10 RTD, alpha .00427, °F <b>Cu °C</b> Cu10 RTD, alpha .00427, °C
	<b>OHnnS</b> Ohmmeter Set decimal point under <b>dEc.Pt</b>	<b>20</b> 0 to 20.000 ohms <b>200</b> 0 to 200.00 ohms <b>2000</b> 0 to 2000.0 ohms <b>20000</b> 0 to 20000 ohms <b>200.00</b> 0 to 200.00 kohm
<b>SEtuP</b> Meter Setup	<b>00_00</b> Display selection with scale factor of 1.	<b>0</b> 0.1° RTD or 4-1/2 digits for ohms <b>1</b> 5-digit remote display (±99,999) <b>2</b> 0.01° RTD, 4-1/2 digit ohms count by 10 <b>3</b> 1° RTD or 3-1/2 digits for ohms
	<b>00_00</b> Power line frequency	<b>0</b> Noise minimized for 60 Hz <b>1</b> Noise minimized for 50 Hz
	<b>00_00</b> Scaling method	<b>0</b> Scale and offset method (RTD & ohms) <b>1</b> Coordinates of 2 points (ohms) <b>2</b> Reading coordinates of 2 points (ohms)
	<b>00_00</b> Control inputs 1 & 2: <b>True</b> = logic 1 (0V or tied to digital ground) <b>False</b> = logic 0 (5V or open)	<b>0</b> 1 = Reset, 2 = Meter Hold <b>1</b> 1 = Function Reset, 2 = Peak or Valley <b>2</b> 1 = Hold, 2 = Peak or Valley Display <b>3</b> 1 = Hold, 2 = Tare <b>4</b> 1 = Peak or Valley Display, 2 = Tare <b>5</b> 1 = Tare, 2 = Reset <b>6</b> 1 = 0, 2 = 0, decimal point 1 = XXXXX 1 = 1, 2 = 0, decimal point 1 = XXXX.X 1 = 0, 2 = 1, decimal point 1 = XXX.XX 1 = 1, 2 = 1, decimal point 1 = XX.XXX <b>7</b> 1 = 0, 2 = 0, decimal point 2 = XXXX.X 1 = 1, 2 = 0, decimal point 2 = XXX.XX 1 = 0, 2 = 1, decimal point 2 = XX.XXX 1 = 1, 2 = 1, decimal point 2 = X.XXXX

<b>MENU</b>  <b>Press Menu Select Key</b>	<b>PEAK</b>  <b>Press Digit Select Key</b>	<b>RESET</b>  <b>Press Value Select Key</b>														
<b>SEtuP</b> Meter Setup (continued)	<b>00_00</b> Control inputs 1 & 2 (continued)	<b>8</b> 1 = Function Reset 2 = Display Blank <b>9</b> 1 = Hold 2 = Display Blank <b>A</b> 1 = Peak or Valley 2 = Display Blank <b>B</b> 1 = Tare 2 = Display Blank <b>C</b> 1 = Valley Display 2 = Peak Display <b>D</b> 1 = Tare 2 = Tare Reset <hr/> Both control inputs 1 & 2 set to 1 for selections <b>2, 4, A, C</b> = Function Reset. Both control inputs 1 & 2 set to 1 for selections <b>0, 1, 3, 5, 8, 9, B, D</b> = Meter Reset.														
<b>ConFG</b> Meter Configuration	<b>00000</b> Operation as a rate of change meter. Extended meter only.	<b>0</b> Not rate of change <b>3</b> Rate x 10 <b>1</b> Rate x 0.1 <b>5</b> Rate x 1000 <b>2</b> Rate x 1 <b>6</b> Rate x 10000														
	<b>00000</b> Operation of front panel <b>PEAK</b> button and rear connector for Peak or Valley Display	<b>0</b> Peak Display. Also selects "Peak" in "Peak or Valley" at connector above. <b>1</b> Valley Display. Also selects "Valley" in "Peak or Valley" at connector above. <b>2</b> Peak (1st push), Valley (2nd push) <b>3</b> Front panel Tare														
	<b>00000</b> Auto-tare selection	<b>0</b> No auto-tare <b>1</b> Auto-tare														
	<b>00000</b> RTD or Ohms wiring	<table border="0"> <tr> <td></td> <td>RTD</td> <td>Ohms</td> </tr> <tr> <td><b>00</b></td> <td>3 or 4 wire</td> <td>3 or 4 wire</td> </tr> <tr> <td><b>01</b></td> <td>Not allowed</td> <td>Custom curve</td> </tr> <tr> <td><b>10</b></td> <td>2-wire read</td> <td>2-wire read</td> </tr> <tr> <td><b>11</b></td> <td>2-wire short</td> <td>2-wire short</td> </tr> </table>		RTD	Ohms	<b>00</b>	3 or 4 wire	3 or 4 wire	<b>01</b>	Not allowed	Custom curve	<b>10</b>	2-wire read	2-wire read	<b>11</b>	2-wire short
	RTD	Ohms														
<b>00</b>	3 or 4 wire	3 or 4 wire														
<b>01</b>	Not allowed	Custom curve														
<b>10</b>	2-wire read	2-wire read														
<b>11</b>	2-wire short	2-wire short														
<b>FiLtr</b> Filtering	<b>00000</b> Alarm filtering	<b>0</b> Unfiltered output <b>1</b> Filtered output														
	<b>00000</b> Peak & Valley filtering	<b>0</b> Unfiltered Peak & Valley <b>1</b> Filtered Peak & Valley														
	<b>00000</b> Display filtering	<b>0</b> Display batch average every 16 readings <b>1</b> Display filtered signal														
	<b>00000</b> Adaptive filter threshold	<b>0</b> Low adaptive filter threshold level <b>1</b> High adaptive filter threshold level														

<b>MENU</b> <b>Press Menu Select Key</b>	<b>PEAK</b> <b>Press Digit Select Key</b>	<b>RESET</b> <b>Press Value Select Key</b>
<b>FiLtr</b> Filtering (continued)	<b>00000</b> Input signal filtering. <i>Can be applied to display, setpoint, analog output, data output.</i>	<b>0</b> Autofilter <b>1</b> Batch average, 16 readings <b>2</b> Moving average, 0.08 sec. <b>3</b> Moving average, 0.15 sec. <b>4</b> Moving average, 0.3 sec. <b>5</b> Moving average, 0.6 sec. <b>6</b> Moving average, 1.2 sec. <b>7</b> Moving average, 2.4 sec. <b>8</b> Moving average, 4.8 sec. <b>9</b> Moving average, 9.6 sec. <b>A</b> Unfiltered
<b>dEc.Pt</b> Decimal point selection	<b>d_ddd</b> Decimal point flashes if ohms are selected under <b>InPut</b>	<b>d_ddd</b> <b>dd_ddd</b> <b>ddd_dd</b> <b>ddd_d</b> <b>ddd_d</b> <b>_ddd</b>
<b>SCALE</b> Scale factor	<b>0.0000</b> <b>0.0000</b> <b>0.0000</b> <b>0.0000</b> <b>0.0000</b> <b>0.0000</b> Select digit to flash.	Select <b>-9</b> thru <b>9</b> for flashing first digit, <b>0</b> thru <b>9</b> for other flashing digits. Select decimal point location when decimal point is flashing.
<b>OFFst</b> Offset value	<b>0.0000</b> <b>0.0000</b> <b>0.0000</b> <b>0.0000</b> <b>0.0000</b> Select digit to flash.	Select <b>-9</b> thru <b>9</b> for flashing first digit, <b>0</b> thru <b>9</b> for other flashing digits. Use offset for display in Rankine or Kelvin. Decimal point location is selected by <b>dEC.Pt</b> .
Option board dependent menu items		
<b>ALSEt</b> <b>ALS34</b> <b>dEU1H</b> <b>dEU2H</b> <b>dEU1b</b> <b>dEU2b</b> <b>dEU3H</b> <b>DEU4H</b> <b>DEU3b</b> <b>DEU4b</b> Menu items related to <b>alarm setup</b> . These will only appear if a relay board is detected. If so, please see Section 16.		
<b>AnSEt</b> <b>An Lo</b> <b>An Hi</b> Menu items related to <b>analog output setup</b> . These will only appear if an analog output board is detected. If so, see Section 17.		
<b>Ser 1</b> <b>Ser 2</b> <b>Ser 3</b> <b>Ser 4</b> <b>Addr</b> Menu items related to <b>serial communications</b> . These will only appear if an RS232, RS485, or USB I/O board is detected. If so, see Section 18.		
Menu lockout items		
<b>Loc 1</b> <b>Loc 2</b> <b>Loc 3</b> Menu items used to enable or lock out (hide) other menu items. <b>Loc</b> menu items may in turn be locked out by a hardware jumper. Please see Section 9.		

## 16. DUAL OR QUAD RELAY OUTPUT OPTION

An optional relay board may be installed in the meter main board at plug position P2, adjacent to the power supply board. Four board versions are available: 2 or 4 relays, mechanical or solid state. Once installed, the relay board is recognized by the meter software or PC-based Instrument Setup software, which will bring up the appropriate menu items for the type of board. These menu items will not be brought up if no relay board is detected. Menu selections for relays 3 and 4 will not be brought up if the dual relay board is detected. All relay boards offer a choice of operating modes: normally off or on, latched or non-latched, hysteresis band, deviation band, alarm based on the filtered or unfiltered signal, and selectable number of readings in alarm zone to cause an alarm.







### KEYSTROKES FOR VIEWING & CHANGING SETPOINTS

The **←** (Alarms) key can be used to step through and view setpoints while the meter continues to make conversions and performs setpoint control. If the **▶** (Peak) key is pressed while a setpoint is displayed, conversion stops and the setpoint can be changed. After pressing **←**, you have 30 seconds, or the meter reverts to the normal display. To view setpoints, menu item Loc3, digit 2, must have been set to 0. To change setpoints, menu item Loc2, digit 2, must have been set to 0.



<b>ALARMS</b> <b>←</b> Press Alarms Key	<b>PEAK</b> <b>▶</b> Press Digit Select Key	<b>RESET</b> <b>▲</b> Press Value Select Key
<b>300.24</b> Press <b>←</b> (Alarms) to display Alarm 1 setpoint.	<b>200.00</b> Current setpoint 1 value blinks, and Alarm 1 LED indicator lights. Press <b>▶</b> to select a digit, which will blink.	<b>295.00</b> To change setpoint 1 value, press <b>▲</b> to change selected blinking digits.
<b>395.00</b> Press <b>←</b> (Alarms) to display Alarm 2 setpoint.	<b>395.00</b> Current setpoint 2 value blinks, and Alarm 2 LED indicator lights. Press <b>▶</b> to select a digit, which will blink.	<b>305.00</b> To change setpoint 2 value, press <b>▲</b> to change selected blinking digits.
<b>395.00</b> Press <b>←</b> (Alarms) to display Alarm 3 setpoint.	<b>395.00</b> Current setpoint 3 value blinks, and Alarm 3 LED indicator lights. Press <b>▶</b> to select a digit, which will blink.	<b>305.00</b> To change setpoint 3 value, press <b>▲</b> to change selected blinking digits.
<b>395.00</b> Press <b>←</b> (Alarms) to display Alarm 4 setpoint.	<b>395.00</b> Current setpoint 4 value blinks, and Alarm 4 LED indicator lights. Press <b>▶</b> to select a digit, which will blink.	<b>305.00</b> To change setpoint 4 value, press <b>▲</b> to change selected blinking digits.
<b>300.24</b> Press <b>←</b> (Alarms) again. Meter will reset and display current reading.		

## KEYSTROKES FOR SETPOINT SETUP

If the *MENU*  key does not work, see Section 9 “Enabling & Locking Out Menu Items.”

 <i>Press Menu Select Key</i>	 <i>Press Digit Select Key</i>	 <i>Press Value Select Key</i>
<b>ALSEt</b> Alarm Setup for relays 1 & 2 if detected.  Press  until <i>ALSEt</i> is displayed.	<b>00000</b> Relay alarm state when alarm is active.	<b>0</b> Relay 1 active on      Relay 2 active on <b>1</b> Relay 1 active off      Relay 2 active on <b>2</b> Relay 1 active on      Relay 2 active off <b>3</b> Relay 1 active off      Relay 2 active off
	<b>00000</b> Alarm latching or non-latching (auto reset).	<b>0</b> AL1 non-latching      AL2 non-latching <b>1</b> AL1 latching      AL2 non-latching <b>2</b> AL1 non-latching      AL2 latching <b>3</b> AL1 latching      AL2 latching
	<b>00000</b> Alarm operates at and above setpoint (active high) or at and below setpoint (active low).	<b>0</b> AL1 active high      AL2 active high <b>1</b> AL1 active low      AL2 active high <b>2</b> AL1 disabled      AL2 active high <b>3</b> AL1 active high      AL2 active low <b>4</b> AL1 active low      AL2 active low <b>5</b> AL1 disabled      AL2 active low <b>6</b> AL1 active high      AL2 disabled <b>7</b> AL1 active low      AL2 disabled <b>8</b> AL1 disabled      AL2 disabled
	<b>00000</b> Hysteresis mode or band deviation mode	<b>0</b> AL1 band deviation      AL2 band deviation <b>1</b> AL1 split hysteresis      AL2 band deviation <b>2</b> AL1 band deviation      AL2 split hysteresis <b>3</b> AL1 split hysteresis      AL2 split hysteresis <b>4</b> No deviation or hysteresis in menu. <b>5</b> AL1 span hysteresis      AL2 band deviation <b>6</b> AL1 span hysteresis      AL2 split hysteresis <b>7</b> AL1 span hysteresis      AL2 span hysteresis
	<b>00000</b> Number of consecutive readings in alarm zone to cause an alarm.	<b>0</b> After 1 reading <b>4</b> After 16 readings <b>1</b> After 2 readings <b>5</b> After 32 readings <b>2</b> After 4 readings <b>6</b> After 64 readings <b>3</b> After 8 readings <b>7</b> After 128 reading
<b>ALS34</b> Alarm Setup for relays 3 & 4 if detected.	<b>00000</b> Relay alarm state when alarm is active.	<b>0</b> Relay 3 active on      Relay 4 active on <b>1</b> Relay 3 active off      Relay 4 active on <b>2</b> Relay 3 active on      Relay 4 active off <b>3</b> Relay 3 active off      Relay 4 active off
	<b>00000</b> Alarm latching or non-latching (auto reset).	<b>0</b> AL3 non-latching      AL4 non-latching <b>1</b> AL3 latching      AL4 non-latching <b>2</b> AL3 non-latching      AL4 latching <b>3</b> AL3 latching      AL4 latching



<b>MENU</b>  <b>Press Menu Select Key</b>	<b>PEAK</b>  <b>Press Digit Select Key</b>	<b>RESET</b>  <b>Press Value Select Key</b>										
<b>ALS34</b> Alarm Setup for relays 3 & 4 (continued)	<b>00000</b> Alarm operates at and above setpoint (active high) or at and below setpoint (active low).	<b>0</b> AL3 active high      AL4 active high <b>1</b> AL3 active low      AL4 active high <b>2</b> AL3 disabled      AL4 active high <b>3</b> AL3 active high      AL4 active low <b>4</b> AL3 active low      AL4 active low <b>5</b> AL3 disabled      AL4 active low <b>6</b> AL3 active high      AL4 disabled <b>7</b> AL3 active low      AL4 disabled <b>8</b> AL3 disabled      AL4 disabled										
	<b>00000</b> Hysteresis mode or band deviation mode (see Glossary)	<b>0</b> AL3 band deviation      AL4 band deviation <b>1</b> AL3 hysteresis      AL4 band deviation <b>2</b> AL3 band deviation      AL4 split hysteresis <b>3</b> AL3 hysteresis      AL4 hysteresis										
	<b>00000</b> Number of consecutive readings in alarm zone to cause an alarm.	<b>0</b> After 1 reading <b>4</b> After 16 readings <b>1</b> After 2 readings <b>5</b> After 32 readings <b>2</b> After 4 readings <b>6</b> After 64 readings <b>3</b> After 8 readings <b>7</b> After 128 reading										
<b>dEU1H</b> Alarm 1 hysteresis	<b>0.0000 0.0000 0.0000</b> <b>0.0000 0.0000</b> Select digit to flash.	Select <b>9</b> thru <b>9</b> for flashing first digit, <b>0</b> thru <b>9</b> for other flashing digits. Alarms will activate above the setpoint by the value entered and deactivate below the setpoint by the value entered.										
<b>DEU2H</b> Alarm 2 hysteresis			<b>DEU1b</b> Alarm 1 band deviation	<b>0.0000 0.0000 0.0000</b> <b>0.0000 0.0000</b> Select digit to flash.	Select <b>9</b> thru <b>9</b> for flashing first digit, <b>0</b> thru <b>9</b> for other flashing digits. Alarms will activate above and below the setpoint by the value entered and will deactivate in the middle of the band.	<b>DEU2b</b> Alarm 2 band deviation	<b>dEU3H</b> Alarm 3 hysteresis	<b>0.0000 0.0000 0.0000</b> <b>0.0000 0.0000</b> Select digit to flash.	Select <b>9</b> thru <b>9</b> for flashing first digit, <b>0</b> thru <b>9</b> for other flashing digits. Alarms will activate above the setpoint by the value entered and deactivate below the setpoint by the value entered.	<b>DEU4H</b> Alarm 4 hysteresis	<b>DEU3b</b> Alarm 3 band deviation	<b>0.0000 0.0000 0.0000</b> <b>0.0000 0.0000</b> Select digit to flash.
<b>DEU1b</b> Alarm 1 band deviation	<b>0.0000 0.0000 0.0000</b> <b>0.0000 0.0000</b> Select digit to flash.	Select <b>9</b> thru <b>9</b> for flashing first digit, <b>0</b> thru <b>9</b> for other flashing digits. Alarms will activate above and below the setpoint by the value entered and will deactivate in the middle of the band.										
<b>DEU2b</b> Alarm 2 band deviation			<b>dEU3H</b> Alarm 3 hysteresis	<b>0.0000 0.0000 0.0000</b> <b>0.0000 0.0000</b> Select digit to flash.	Select <b>9</b> thru <b>9</b> for flashing first digit, <b>0</b> thru <b>9</b> for other flashing digits. Alarms will activate above the setpoint by the value entered and deactivate below the setpoint by the value entered.	<b>DEU4H</b> Alarm 4 hysteresis	<b>DEU3b</b> Alarm 3 band deviation	<b>0.0000 0.0000 0.0000</b> <b>0.0000 0.0000</b> Select digit to flash.	Select <b>9</b> thru <b>9</b> for flashing first digit, <b>0</b> thru <b>9</b> for other flashing digits. Alarms will activate above and below the setpoint by the value entered and will deactivate in the middle of the band.	<b>DEU4b</b> Alarm 4 band deviation		
<b>dEU3H</b> Alarm 3 hysteresis	<b>0.0000 0.0000 0.0000</b> <b>0.0000 0.0000</b> Select digit to flash.	Select <b>9</b> thru <b>9</b> for flashing first digit, <b>0</b> thru <b>9</b> for other flashing digits. Alarms will activate above the setpoint by the value entered and deactivate below the setpoint by the value entered.										
<b>DEU4H</b> Alarm 4 hysteresis			<b>DEU3b</b> Alarm 3 band deviation	<b>0.0000 0.0000 0.0000</b> <b>0.0000 0.0000</b> Select digit to flash.	Select <b>9</b> thru <b>9</b> for flashing first digit, <b>0</b> thru <b>9</b> for other flashing digits. Alarms will activate above and below the setpoint by the value entered and will deactivate in the middle of the band.	<b>DEU4b</b> Alarm 4 band deviation						
<b>DEU3b</b> Alarm 3 band deviation	<b>0.0000 0.0000 0.0000</b> <b>0.0000 0.0000</b> Select digit to flash.	Select <b>9</b> thru <b>9</b> for flashing first digit, <b>0</b> thru <b>9</b> for other flashing digits. Alarms will activate above and below the setpoint by the value entered and will deactivate in the middle of the band.										
<b>DEU4b</b> Alarm 4 band deviation												

## 17. ANALOG OUTPUT OPTION

An optional analog board may be installed in the meter at rear panel jack position J4, adjacent to the signal conditioner board. Once installed, this board is recognized by the meter, which will bring up the appropriate menu items for it. These will not be brought up if an analog output board is not installed.

The analog output can be a 0-20 mA, 4-20 mA or 0-10V unipolar signal with respect to isolated ground, or a bipolar -10V to +10V voltage signal with respect to a reference return line. Unipolar or bipolar operation is selected by a jumper. A unipolar current or voltage output is selected at the connector. Unipolar 4-20 mA or 0-20 mA current is selected in software.

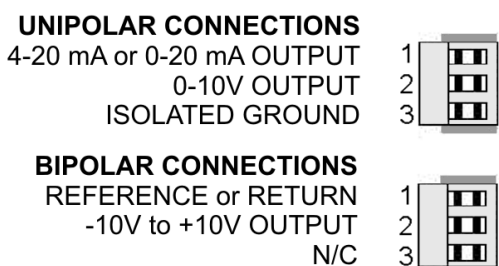
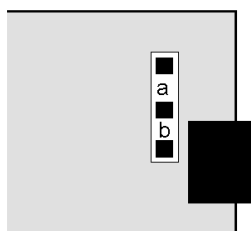

Unipolar current of voltage: Jumper **a**  
 Bipolar -10 to +10 voltage: Jumper **b**

The low analog output (0 mA, 4 mA, 0V, or -10V) may be set to correspond to any low displayed reading **An Lo**. The high analog output (20 mA, 0V or 10V) may be set to correspond to any high displayed reading **An Hi**. The meter will then apply a straight line fit between these two end points to provide an analog output scaled to the meter reading.

### KEYSTROKES FOR SETUP

If the **MENU** key does not work, see Section 9 “Enabling & Locking Out Menu Items.”

<b>Press Menu Select Key</b>	<b>Press Digit Select Key</b>	<b>Press Value Select Key</b>
<b>AnSEt</b> Analog Output Setup. Press  until <b>AnSEt</b> is displayed (requires analog output board).	<b>00</b> Analog output signal selection.	<b>0</b> 0-20 mA current output <b>1</b> 0-10V voltage output <b>2</b> 4-20 mA current output <b>3</b> -10 to +10V voltage output
	<b>00</b> Analog output filtering.	<b>0</b> Analog output unfiltered <b>1</b> Analog output filtered
<b>An Lo</b> Low displayed value for 0 mA, 4 mA, 0V, or -10V output	<b>0.0000 0.0000 0.0000</b> <b>0.0000 0.0000</b> Select digit to flash.	Select <b>-9</b> thru <b>9</b> for flashing first digit, <b>0</b> thru <b>9</b> for other flashing digits. Decimal point location is fixed by <b>dEC.Pt</b> selection.
<b>An Hi</b> High displayed value for 20 mA or 10V output	<b>0.0000 0.0000 0.0000</b> <b>0.0000 0.0000</b> Select digit to flash.	Select <b>-9</b> thru <b>9</b> for flashing first digit, <b>0</b> thru <b>9</b> for other flashing digits. Decimal point location is fixed by <b>dEC.Pt</b> selection.

## 18. SERIAL COMMUNICATION OPTIONS

A **serial communications board** may be connected to the meter main board at plug position P13 (middle position). Available boards are RS232, RS485 (with dual RJ11 connectors), RS485 Modbus (with dual RJ45 connectors), USB, USB-to-RS485 converter, Ethernet, and Ethernet-to-RS485 converter. The dual connectors of RS485 boards are wired in parallel to allow daisy chaining of addressable meters without use of a hub. Three serial communication protocols are selectable for all serial boards: Custom ASCII, Modbus RTU, and Modbus ASCII.

A **USB-to-RS485 converter board** or an **Ethernet-to-RS485 converter board** allows a meter to be interfaced to a computer and be the device server for a network of up to 31 other meters on an RS485 bus, while itself retaining all capabilities of a meter. The remote meters need to be equipped with our RS485 digital interface board with dual 6-pin RJ11 jacks, not our RS485 digital interface with dual 8-pin RJ45 jacks. The dual 6-pin RJ11 jacks on the RS485 board are wired in parallel to allow multiple meters to be daisy-chained using 6-wire data cables with no need for hand-wiring or an RS485 hub. The outer two wires are used for ground.

**Use 6-wire, straight-through data cables**, not 4-wire telephone cables or crossover cables, all the way from the device server to the last device on the RS485 bus. Connect ATX to ATX, BTX to BTX, etc., with no crossover as you go from device to device.

**To connect a meter with a USB board to a Windows PC**, use a USB cable with Type A and Type B connectors. Upon first connection, your computer may display “Found new Hardware” and automatically download and install the required USB driver from the Internet. If installation is not automatic, download the driver file (with a name like CDM v2.10.00 WHQL Certified.zip) from <http://www.ftdichip.com/Drivers/VCP.htm>. Unzip it into its own directory, and point to that directory as the location of the driver. You will need to use Device Manager (accessible from Control Panel) to determine the com port. Go down the device list and click on Ports (COM & LPT) and USB serial port (com #). Note the com port # for use with communications to your meter, then exit Control Panel. If you later need to change the Com port, right-click on USB serial port (com #), then on Properties, Port settings, and Advanced. Change port to the desired number, click OK, then exit Control Panel.

**To connect a meter with an Ethernet board to a computer**, see our separate Ethernet Manual, which covers our Node Manager Software. This Windows-based application runs on a host computer and is used to configure our Ethernet Nodes. It automatically discovers all Nodes on a LAN or WAN, plus any devices connected to Server Nodes via an RS485 bus. It is used to configure each Node, such as setting communication parameters, naming the Node and associated devices, entering email addresses for alarm notification and data requests, selecting the Node's time zone for time-stamping of emails and streaming data, and upgrading firmware. Once configuration data has been stored in flash memory of all Nodes, Node Manager Software can be closed. Node resident web server software is also provided.

### BOARD SETUP VIA JUMPERS

<p><b>USB Board</b> No jumpers required.</p>	 <p>The diagram shows a rectangular board with a single port on the right side labeled 'USB'.</p>
--	--

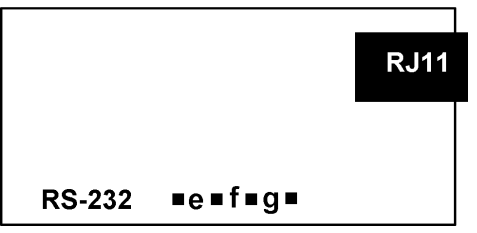
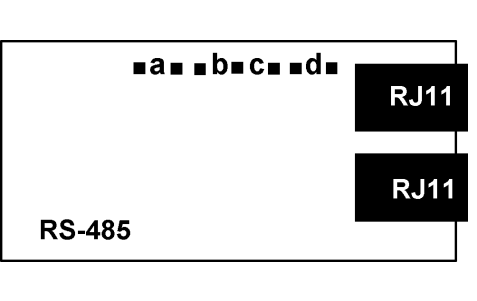
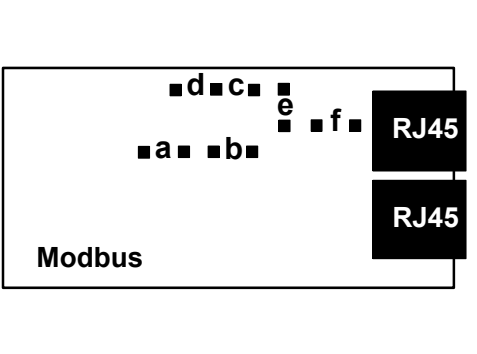
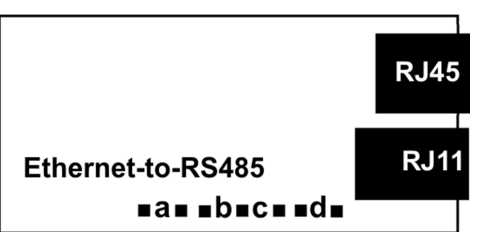
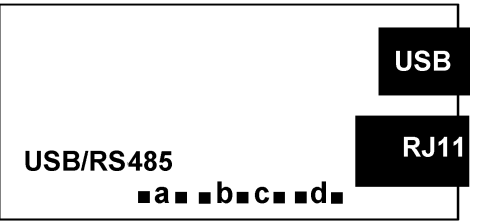
<p><b>Basic Ethernet Board</b> No jumpers needed.</p>	 <p>Ethernet</p> <p>RJ45</p>
<p><b>RS232 Board</b> e - Normal operation. f - Slave display to RS232 from another meter. g - Pull-up resistor on RTS line. <b>Note:</b> Board is shipped with jumpers e and g installed</p>	 <p>RS-232 ■ e ■ f ■ g ■</p> <p>RJ11</p>
<p><b>RS485 Board, Full Duplex Operation</b> b &amp; d - Installed on last meter in long cable run. <b>RS485 Board, Half Duplex Operation</b> a &amp; c - Installed for half duplex operation. d - Installed on last meter in line with long cable runs. <b>Note:</b> Board is shipped with no jumpers installed.</p>	 <p>■ a ■ b ■ c ■ d ■</p> <p>RS-485</p> <p>RJ11</p> <p>RJ11</p>
<p><b>RS485-Modbus Board, Full Duplex Operation</b> b &amp; e - Bias jumpers should be installed on 1 board. a &amp; d - Installed on last meter in long cable run. <b>RS485-Modbus Board, Half Duplex Operation</b> b &amp; e - bias jumpers installed on 1 board. c &amp; f - installed for half duplex operation. a - installed on last meter in line with long cable runs. <b>Note:</b> Board is shipped with no jumpers installed.</p>	 <p>■ d ■ c ■ e ■ f ■</p> <p>■ a ■ b ■</p> <p>Modbus</p> <p>RJ45</p> <p>RJ45</p>
<p><b>Ethernet-to-RS485 Converter Board &amp; USB-to-RS485 Converter Board</b> <b>Full Duplex Operation</b> No jumpers for short cable runs. Add b &amp; d for long cable runs. <b>Half Duplex Operation</b> a &amp; c - Installed for half duplex operation. d - Installed on last meter in line with long cable runs.</p>	 <p>Ethernet-to-RS485</p> <p>■ a ■ b ■ c ■ d ■</p> <p>RJ45</p> <p>RJ11</p>  <p>USB/RS485</p> <p>■ a ■ b ■ c ■ d ■</p> <p>USB</p> <p>RJ11</p>

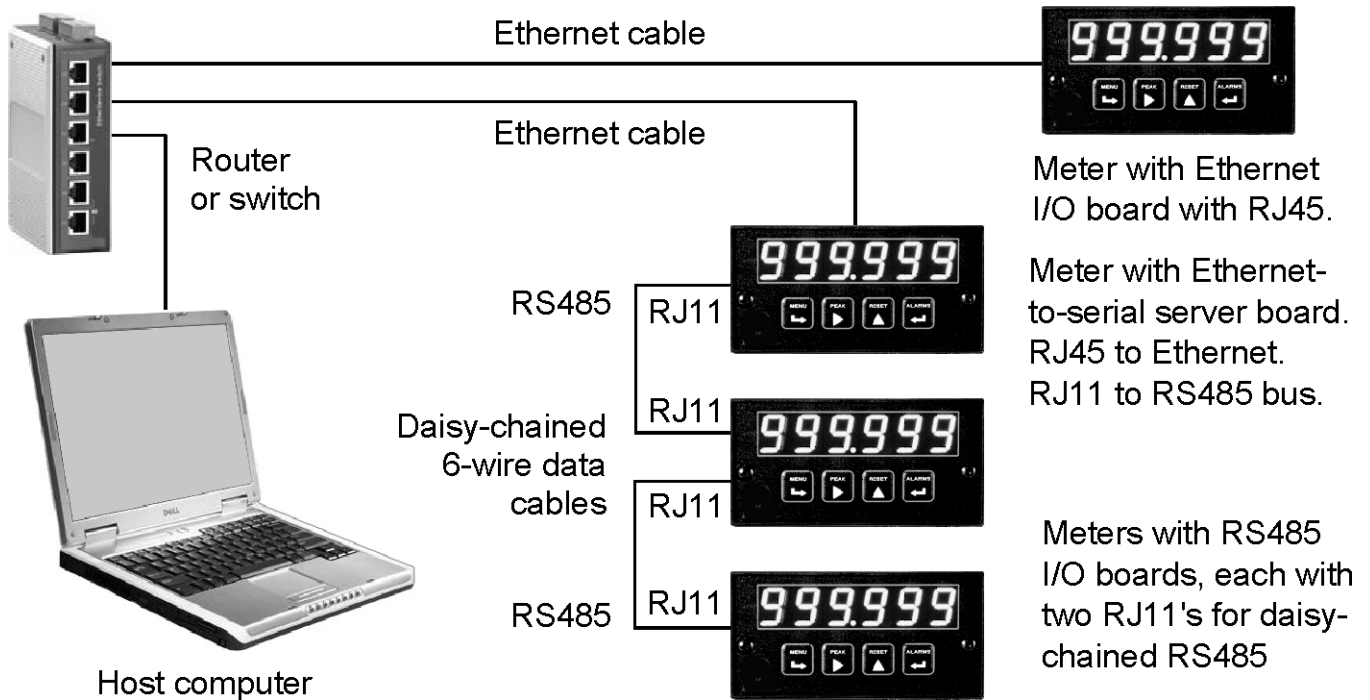
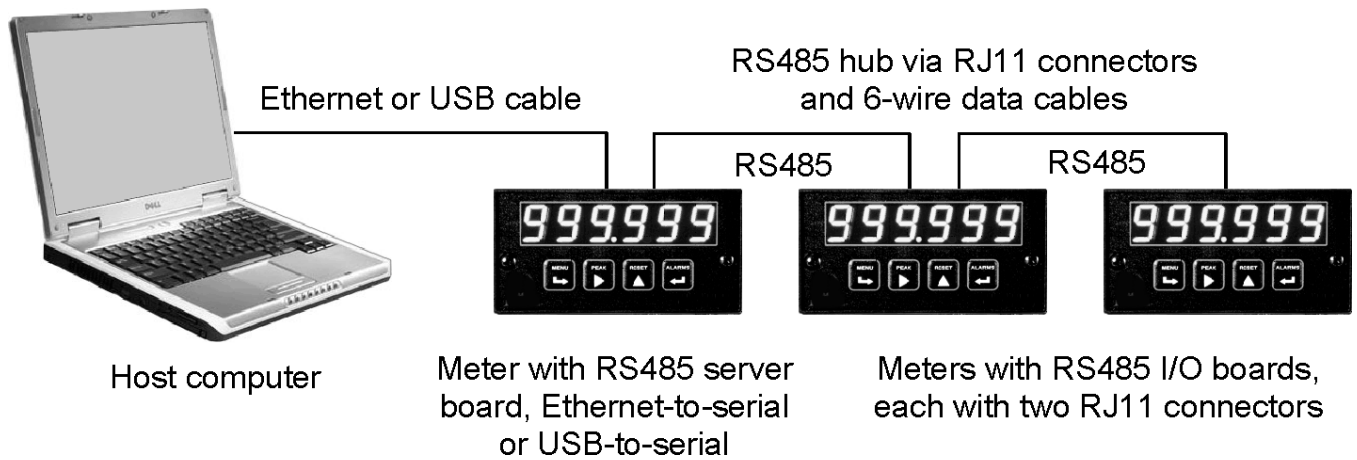
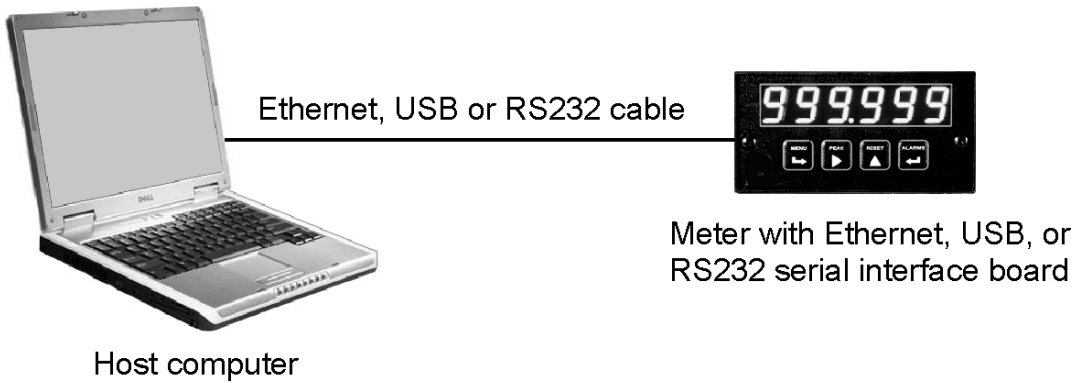

# SERIAL CONNECTION EXAMPLES

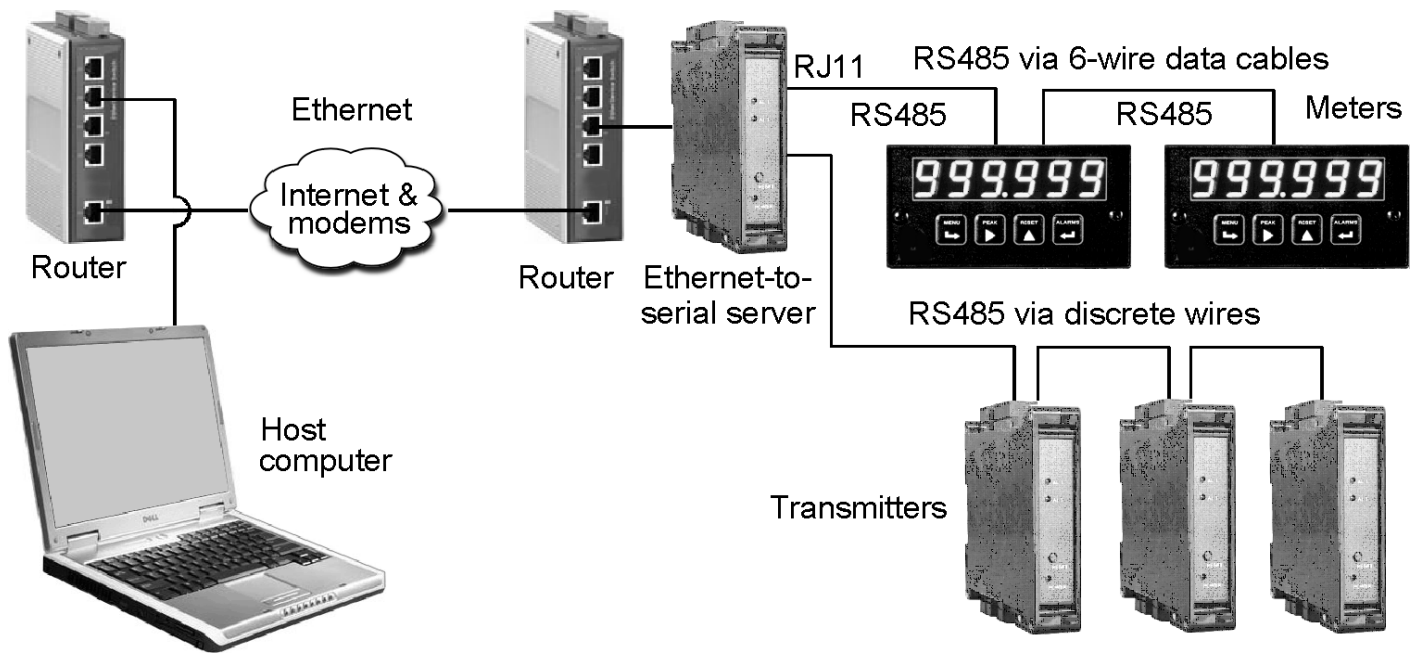





### KEYSTROKES FOR SETUP

If the *MENU*  key does not work, see Section 9 “Enabling & Locking Out Menu Items.”

 <i>Press Menu Select Key</i>	 <i>Press Digit Select Key</i>	 <i>Press Value Select Key</i>																																
<b>SEr 1</b> Fixed Parameters: No parity 8 data bits 1 stop bit	<b>000</b> Output filtering	<b>0</b> Send unfiltered signal <b>1</b> Send filtered signal																																
	<b>000</b> Baud rate	<b>0</b> 300 baud <b>1</b> 600 baud <b>2</b> 1200 baud <b>3</b> 2400 baud <b>4</b> 4800 baud <b>5</b> 9600 baud <b>6</b> 19200 baud																																
	<b>000</b> Output update rate	<table border="0"> <tr> <td></td> <td><u>60 Hz</u></td> <td><u>50 Hz</u></td> </tr> <tr> <td><b>0</b></td> <td>Line frequency</td> <td>Line frequency</td> </tr> <tr> <td><b>1</b></td> <td>0.28 sec</td> <td>0.34 sec</td> </tr> <tr> <td><b>2</b></td> <td>0.57 sec</td> <td>0.68 sec</td> </tr> <tr> <td><b>3</b></td> <td>1.1 sec</td> <td>1.4 sec</td> </tr> <tr> <td><b>4</b></td> <td>2.3 sec</td> <td>2.7 sec</td> </tr> <tr> <td><b>5</b></td> <td>4.5 sec</td> <td>5.4 sec</td> </tr> <tr> <td><b>6</b></td> <td>9.1 sec</td> <td>10.9 sec</td> </tr> <tr> <td><b>7</b></td> <td>18.1 sec</td> <td>21.8 sec</td> </tr> <tr> <td><b>8</b></td> <td>36.6 sec</td> <td>43.5 sec</td> </tr> <tr> <td><b>9</b></td> <td>72.5 sec</td> <td>97 sec</td> </tr> </table>		<u>60 Hz</u>	<u>50 Hz</u>	<b>0</b>	Line frequency	Line frequency	<b>1</b>	0.28 sec	0.34 sec	<b>2</b>	0.57 sec	0.68 sec	<b>3</b>	1.1 sec	1.4 sec	<b>4</b>	2.3 sec	2.7 sec	<b>5</b>	4.5 sec	5.4 sec	<b>6</b>	9.1 sec	10.9 sec	<b>7</b>	18.1 sec	21.8 sec	<b>8</b>	36.6 sec	43.5 sec	<b>9</b>	72.5 sec
	<u>60 Hz</u>	<u>50 Hz</u>																																
<b>0</b>	Line frequency	Line frequency																																
<b>1</b>	0.28 sec	0.34 sec																																
<b>2</b>	0.57 sec	0.68 sec																																
<b>3</b>	1.1 sec	1.4 sec																																
<b>4</b>	2.3 sec	2.7 sec																																
<b>5</b>	4.5 sec	5.4 sec																																
<b>6</b>	9.1 sec	10.9 sec																																
<b>7</b>	18.1 sec	21.8 sec																																
<b>8</b>	36.6 sec	43.5 sec																																
<b>9</b>	72.5 sec	97 sec																																

<b>MENU</b>  <b>Press Menu Select Key</b>	<b>PEAK</b>  <b>Press Digit Select Key</b>	<b>RESET</b>  <b>Press Value Select Key</b>
<b>SEr 2</b> Serial Setup 2	<b>0000</b> Line feed	<b>0</b> No line feed after carriage return <b>1</b> Line feed after carriage return
	<b>0000</b> Alarm data with readings	<b>0</b> No alarm data <b>1</b> Alarm data with reading
	<b>0000</b> Control of data output	<b>0</b> Continuous data output <b>1</b> Data output on ASCII command only
	<b>0000</b> Meter address with Custom ASCII protocol	Select <b>1</b> thru <b>F</b> for addresses 1 thru 15. Select <b>0.</b> thru <b>F.</b> (with decimal point) for addresses 16 thru 31.
<b>SEr 3</b> Serial Setup 3	<b>00000</b> Half or full duplex	<b>0</b> Full duplex <b>1</b> Half duplex
	<b>00000</b> Special start & stop char.	<b>0</b> Standard continuous mode <b>1</b> Special start & stop characters
	<b>00000</b> RTS mode	<b>0</b> Normal RTS <b>1</b> Single transmission
	<b>00000</b> Termination characters	<b>0</b> Only at end of all items <b>1</b> At end of each item
<b>SEr 3</b> Serial Setup 3 (continued)	<b>00000</b> Data sent in continuous mode	<b>0</b> Reading <b>1</b> Peak <b>2</b> Valley <b>3</b> Reading + peak <b>4</b> Reading + valley <b>5</b> Reading + peak + valley
<b>SEr 4</b> Serial Setup 4.	<b>000</b> Modbus ASCII gap timeout	<b>0</b> 1 sec <b>1</b> 3 sec <b>2</b> 5 sec <b>3</b> 10 sec
	<b>000</b> Serial protocol	<b>0</b> Custom ASCII <b>1</b> Modbus RTU <b>2</b> Modbus ASCII
	<b>000</b> Parity	<b>0</b> None, 2 or more stop bits <b>1</b> Odd, 1 or more stop bits <b>2</b> Even, 1 or more stop bits
<b>Addr</b> Modbus Address. Appears only if the Modbus protocol is selected.	<b>000</b> <b>000</b> <b>000</b> Select digit to flash.	<b>247</b> Select <b>0</b> through <b>9</b> for flashing digit. Address range is 1 to 247.

## 19. EXCITATION OUTPUT & POWER SUPPLY

Three isolated transducer excitation output levels are available from the power supply board. These are selectable via jumpers b, c, d, e, f in the upper right of the board, as illustrated. In addition, the board provides three jumper positions for special features. The same jumper locations apply to the universal power supply (85-264 Vac) and to the low voltage power supply (12-32 Vac or 10-48 Vdc).

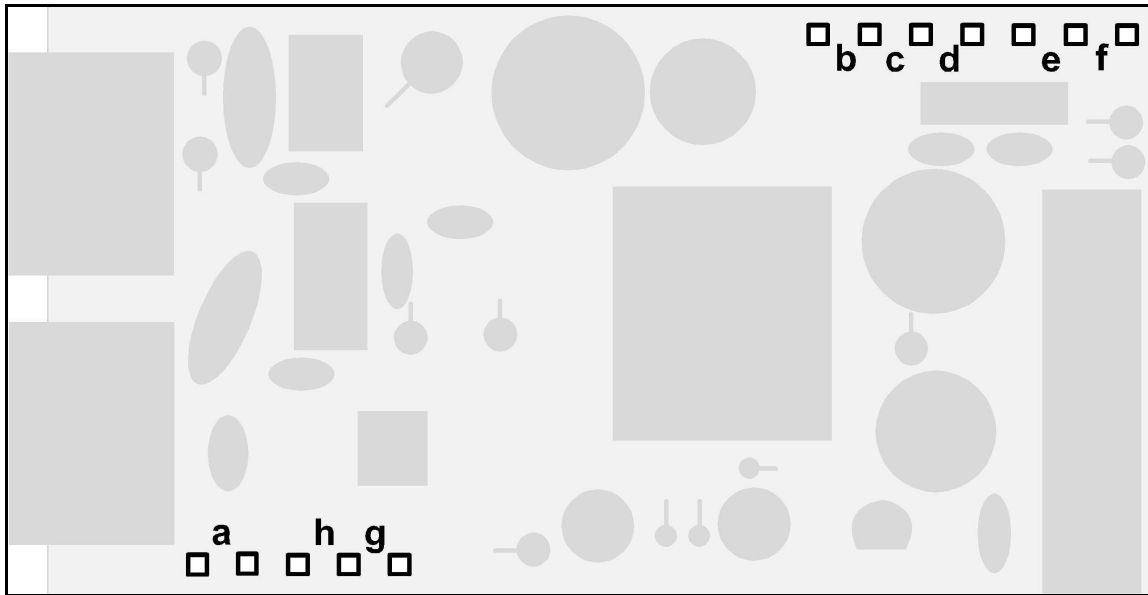

Excitation output	Jumper locations													
5 Vdc $\pm 5\%$ , 100 mA max	b, d, e	<table style="margin: auto; border-collapse: collapse;"> <tr> <td style="text-align: center;">b</td> <td style="text-align: center;">d</td> <td style="text-align: center;">e</td> <td style="width: 20px;"></td> </tr> <tr> <td style="text-align: center;">■</td><td style="text-align: center;">■</td> <td style="text-align: center;">■</td><td style="text-align: center;">■</td> <td style="text-align: center;">■</td><td style="text-align: center;">■</td> <td style="text-align: center;">■</td><td style="text-align: center;">■</td> </tr> </table>	b	d	e		■	■	■	■	■	■	■	■
b	d	e												
■	■	■	■	■	■	■	■							
10 Vdc $\pm 5\%$ , 120 mA max	b, d, f	<table style="margin: auto; border-collapse: collapse;"> <tr> <td style="text-align: center;">b</td> <td style="text-align: center;">d</td> <td style="text-align: center;">f</td> <td style="width: 20px;"></td> </tr> <tr> <td style="text-align: center;">■</td><td style="text-align: center;">■</td> <td style="text-align: center;">■</td><td style="text-align: center;">■</td> <td style="text-align: center;">■</td><td style="text-align: center;">■</td> <td style="text-align: center;">■</td><td style="text-align: center;">■</td> </tr> </table>	b	d	f		■	■	■	■	■	■	■	■
b	d	f												
■	■	■	■	■	■	■	■							
24 Vdc $\pm 5\%$ , 50 mA max	c	<table style="margin: auto; border-collapse: collapse;"> <tr> <td style="text-align: center;">c</td> <td style="width: 20px;"></td> <td style="width: 20px;"></td> <td style="width: 20px;"></td> </tr> <tr> <td style="text-align: center;">■</td><td style="text-align: center;">■</td> <td style="text-align: center;">■</td><td style="text-align: center;">■</td> </tr> </table>	c				■	■	■	■				
c														
■	■	■	■											

### SELECTION OF OTHER JUMPERS

- Jumper a** - Front panel menu lockout, locked when installed. (See Section 9)
- Jumper g** - Provides +5V power output at P1-4 when installed.
- Jumper h** - Connects "Control Input 2" to P1-4 when installed.



## 20. INSTRUMENT SETUP VIA PC

*Instrument Setup* software is a PC program which is much easier to learn than front panel programming. It is of benefit whether or not the meter is connected to a PC. With the meter connected to a PC, it allows uploading, editing and downloading of setup data, execution of commands under computer control, listing, plotting and graphing of data, and computer prompted calibration. With the meter unconnected to a PC, it provides quick selection of jumper locations and a printable display of menu selections for front panel setup.

### SOFTWARE INSTALLATION

Download *IS2\*.exe* onto your PC from the web or the distribution CD. Double-click on the downloaded file to unzip it into a special directory, such as *c:\temp*. Within that directory, double-click on *setup.exe*, which will install the software on your PC.

### PREREQUISITES FOR CONNECTED USE

- 1) PC with an available RS232 or USB port.
- 2) Meter to be set up.
- 3) RS232 or USB board in the meter. This board can be removed following meter setup.
- 4) RJ11-to-DB9 cable from the meter to a PC RS232 com port, or a USB cable to a PC USB port (see Section 1, Ordering Guide).
- 5) *Instrument Setup* software.



RJ11-to-DB9 RS232 cable with rear view of DB9 connector to PC

### ESTABLISHING COMMUNICATIONS

Connect the meter and PC. Apply power to the meter. Be sure that the meter is in Run Mode, not Setup Mode. To start the software from Windows, click on *Start => Programs => IS2 => IS2*. Click on *RS232 => Establish*. The program will temporarily set the selected Com port to the required baud rate, parity, data bits and stop bit. Once communications have been established, click on *Main Menu*. The software will sense the type of meter and installed boards, but it cannot sense jumpers positions nor set jumpers for you. If the computer is not connected to a meter, select *DPM* and *Series 2*.

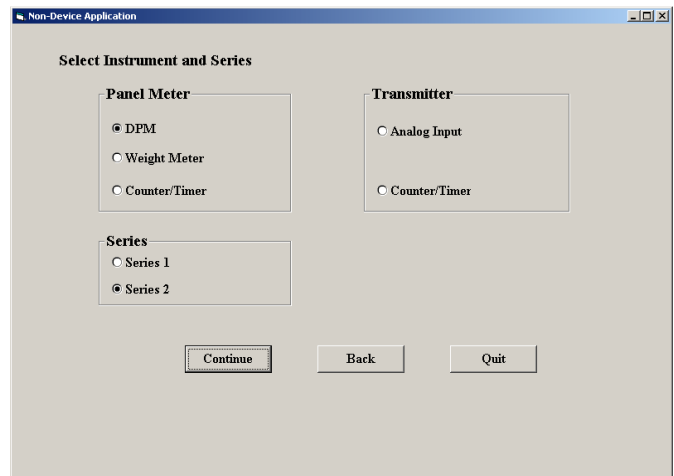
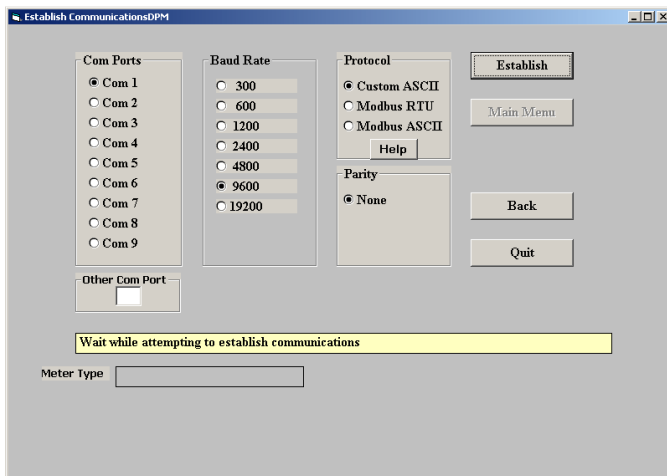

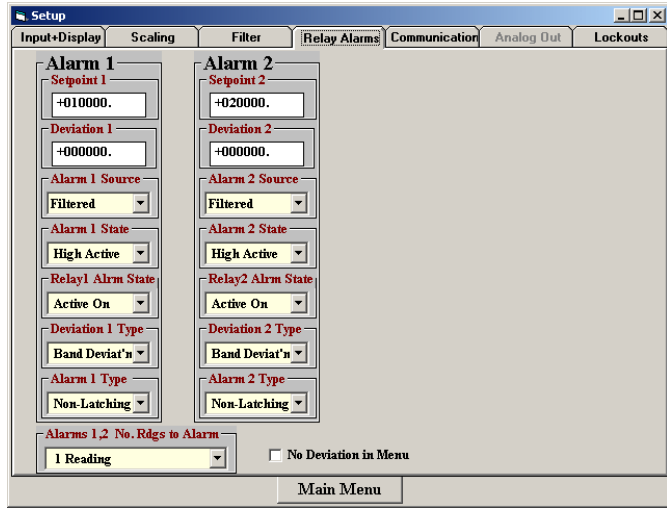
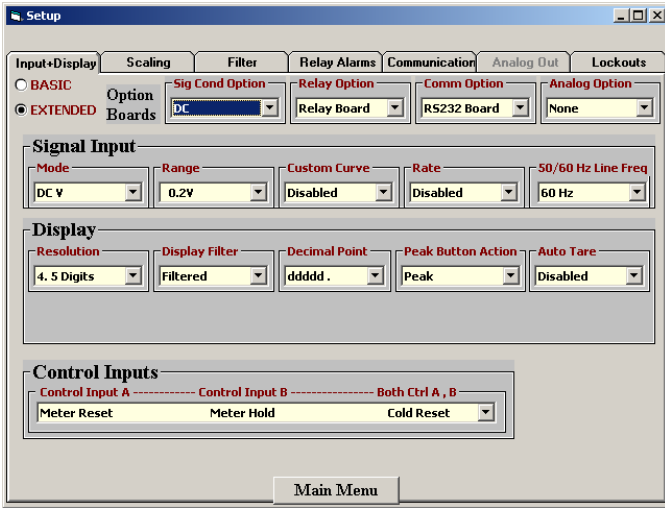

### SETUP OF CONNECTED METER

A setup file can be retrieved from the meter (*DPM => Get Setup*), be edited (*View => Setup*), be saved to disk (*File => Save Setup*), be retrieved from disk (*File => Open Setup*), and be downloaded into one or multiple meters (*DPM => Put Setup*). Downloading of setup files from a PC can be a major time saving when multiple meters have to be set up in the same way.

You will find that *Instrument Setup software* is very user friendly, with separate tab-selectable windows for *Input+Display*, *Scaling*, *Filter*, *Relay Alarms*, *Communications*, *Analog Out*, and *Lockouts*. If the required hardware, such as the analog output board, is not sensed, the corresponding tab will be grayed out.

### ADDITIONAL FEATURES

- **The Commands pull-down menu** allows you to execute certain meter functions by using your computer mouse. You can reset individual meter functions, display current or peak readings, and enter numbers to be displayed remotely by the DPM. The first position of a transmitted number must be a blank, + sign or - sign. Five digits and a decimal point must be transmitted. Leading 0's serve as blanks. The *Commands* pull-down menu will be grayed out unless a *Get Setup* has been executed.

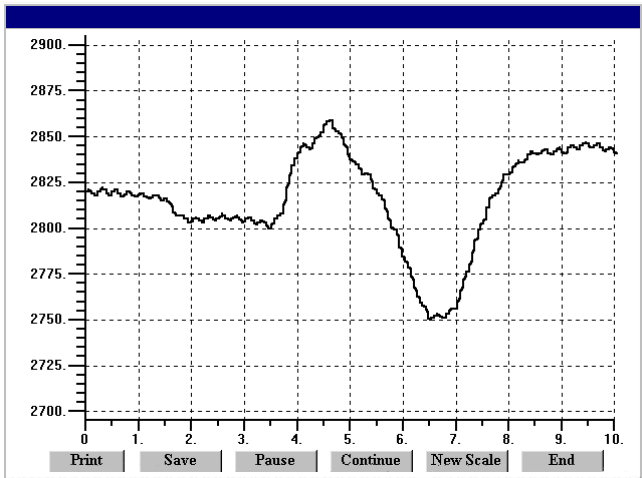

Plot

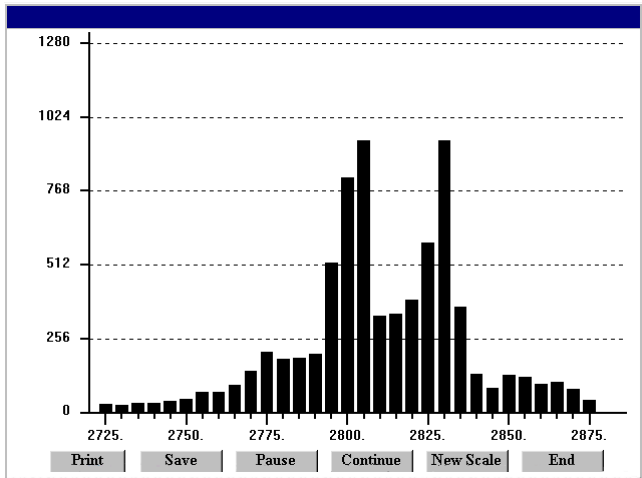

Graph

- **The Readings pull-down menu** provides three formats to display DPM data on the PC monitor. Use the *Pause* and *Continue* buttons to control the timing of data collection, then press **Print** for a hardcopy using your PC printer.
  - **List** presents the latest readings in a 20-row by 10-column table. Press *Pause* at any time to freeze the display. Press *Print* for a hardcopy. *List* can capture peak readings.
  - **Plot** generates a plot of readings vs. time in seconds. It effectively turns the DPM-PC combination into a printing digital oscilloscope.
  - **Graph** generates a histogram, where the horizontal axis is the reading and the vertical axis is the number of occurrences of readings. The display continually resizes itself as the number of readings increases.
- **The Jumpers pull-down menu** provides jumper positions for the various meter boards, duplicating information in this manual.
- **The Calibration pull-down menu** allows easy calibration of voltage and current ranges for the DC, load cell, and AC RMS signal conditioner boards. The PC first recognizes the type of board, then prompts you to apply specific jumpers and calibration signals. Press *Ready* to take a reading. Press *Repeat* to take more readings. When you have decided on which reading to accept, press on the number 1 through 10 of that reading. Additional calibration software is available online.

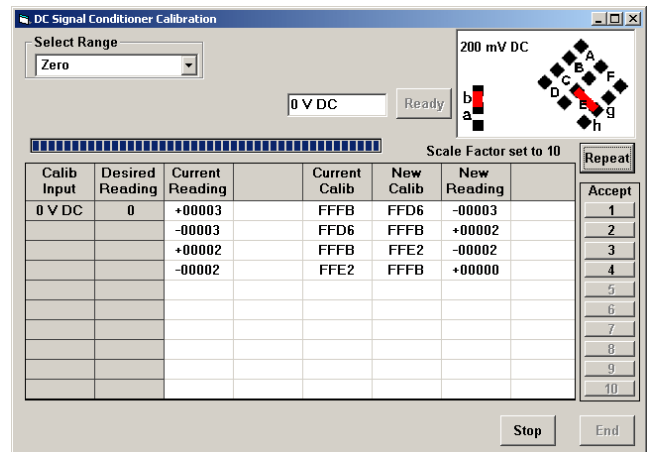

## METER SETUP WITH AN UNCONNECTED PC

*Instrument Setup* software is also of benefit when the PC is not connected to a meter. Upon launching the software, click on *None* for *Communications*, then on *DPM* and *Series 2*. Click on *File => Default Setup* to retrieve a default setup file from disk, or on *File => Open Setup* to retrieve a previously saved setup file from disk.

To enter new setup information, click on *View => Setup*, then make your screen selections as if you were connected to a meter. Tabs will be grayed out if you have not selected the required hardware under the *Input+Display* tab. When done, press on *Main Menu*, then on *View => Menu*. The selections made under *Setup* will now be shown in the form of the required front panel programming sequence, where each row corresponds to a menu item selected by the **→** key, and the seven data columns correspond to values entered via the **▶** and **▲** keys.

MENU KEY	S	1	2	3	4	5
InPut			d	C		V
SEtuP		0	0	0	0	0
ConFiG		0	0	0	0	0
FiLteR		0	0	1	1	6
DecPt		d	d	d.	d	d
SCALE		0	0	0	1	0
OFFSt		0	0	0.	0	0
SEr 1				0	5	0
SEr 2			0	0	1	1
Loc 1		0	0	0	0	0
Loc 2			0	0	1	0
Loc 3			0	0	0	0

Click on any step in the sequence to bring up a detailed help window.

Click on *Print* for a hardcopy, which you can then use as an instruction sheet to program your meter via its front panel.

Click on *Main Menu => File => Save Setup As* to save your setup to disk and have an electronic record.

## 21. CUSTOM CURVE LINEARIZATION

*Curve.exe* is a DOS-based, executable PC program used to set up an Extended meter so that the readings have a user-defined, non-linear relationship with the input signal. The calculated linearizing parameters are downloaded into non-volatile memory of the meter. For example, it allows a meter to correct for transducer nonlinearity or to display volume of an irregularly shaped tank based on liquid level. The curve-fitting algorithm uses quadratic segments of varying length and curvature, and provides diagnostics to estimate curve fitting errors. The program is self-prompting, avoiding the need for a detailed printed manual. This manual section is only intended as an introduction and get-started guide.

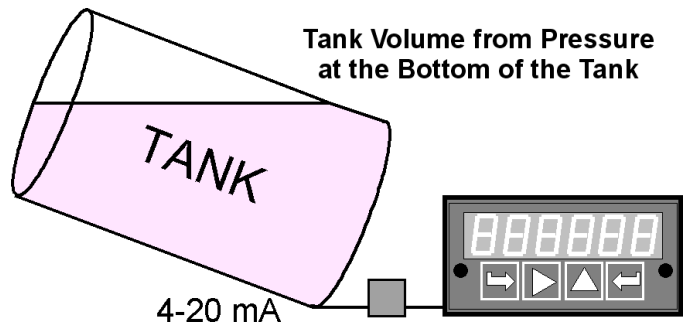

### PREREQUISITES

- 1) PC-compatible computer with an available RS232 or USB port.
- 2) Extended meter.
- 3) An RS232 or USB board in the meter. This board can be removed following meter setup.
- 4) An RJ11-to-DB9 RS232 cable or a USB cable to connect the meter to the PC (see Section 1, Ordering Guide).
- 5) *Curve.exe* software (downloadable from the web at no charge).

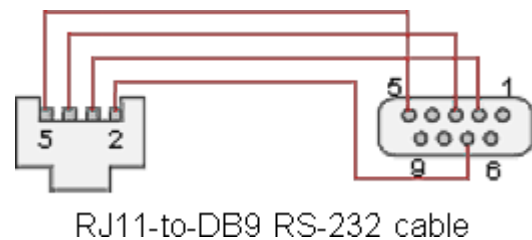

### GETTING STARTED

Download *curve.exe* into the same directory that will contain your data files, such as *c:\curves*. Set the meter baud rate to 9600. To do so, press the **→** key to get to **Ser 1**, then set the entry to **050**. Set the meter address to 1. To do so, press the **→** key to get to **Ser 2**, then set the entry to **0011**. To execute the program from Windows, simply double-click on *curve.exe*, which is an executable file. Follow the steps on computer screens, which will prompt you and provide extensive information. Pressing **R** (Enter) returns to the main menu.

You will be given the choice to enter your data in one of four modes:

- 1) **Text file entry mode**, with an X value in one column and a Y value in another. There can be additional columns, which are ignored. The file must have a DOS name of up to 8 characters and the extension *.RAW*. There can be from 5 to 180 rows. X is the input value and should be in the unit of measure for which the meter was set up, such as mV, V, mA or A. Y is the desired corresponding reading and can range from -99999 to 99999 with any decimal point.
- 2) **2-coordinate keyboard entry mode**, where an actual X input signal is applied, and the desired Y reading is entered from the keyboard.
- 3) **2-coordinate file entry mode**, where an actual X input signal is applied, and the desired Y reading is provided from a file.

- 4) **Equation entry mode**, where the coefficients of a polynomial  $Y = K1X^P1 + K2X^P2 + K3X^P3 + \dots$  are entered. Up to 20 terms are allowed. An offset can be built into X.

You will be asked if your DPM has a revision of DPM4L or later. You will normally select **2** (yes), since revision DPM4L started to ship in August 2000.

You will be asked to supply the following:

LOW X-COORDINATE VALUE >  
LOW INPUT MEASUREMENT VALUE >  
HIGH X-COORDINATE VALUE >  
HIGH INPUT MEASUREMENT VALUE >

This informs the computer of your signal conditioner jumper settings. Enter 0 and 0 for the two LOW values. For HIGH X, enter your signal conditioner jumper range in the same units of measure that you will be using in your \*.RAW data input file. Enter **20** for 20 mV or 20V. Enter **200** for 200 mV or 200V. Enter **5** for 5A AC or DC. For HIGH INPUT MEASUREMENT VALUE, enter **20000**, except for 5A DC, where you should enter **5000**.

Position of the decimal point from 6=X.XXXXX, 5= XX.XXX, 4=XXX.XXX, 3=XXXX.XX, 2=XXXXX.X, 1=XXXXXX (for DPMs, the leading X is a blank). Specify the same position that you specified in the **dEc.Pt** decimal point menu selection.

Follow the steps on the screens to finish generating the custom curve. When prompted to download the file to the meter, select **Y**. When prompted to set the meter to custom curve mode, also select **Y**.

## KEYPAD CONTROL

You can take a meter in and out of custom curve linearization using the meter keypad. From the Menu mode, press the **→** key to get to **ConFG**, then set the fifth digit to either **0** (normal linear operation) or to **1** (custom curve operation). This fifth digit will only be displayed with an Extended meter.

## FILES USED OR CREATED BY CURVE.EXE

- 1) **\*.RAW** is the raw input file generated by all four data entry methods.
- 2) **\*.DVD** adds three columns from which the smoothness of the input data and obvious input errors can be judged. The more data points and the smoother the data, the better the curve fit.
- 3) **\*.NUM** lists Y readings prior to custom curve linearization and addition of the decimal point.
- 4) **\*.CCF** is an internal file used by the software.
- 5) **\*.SIM** lists simulated linearized meter readings and calculated corresponding errors.
- 6) **\*.PRM** contains the final hex data that is downloaded into the meter.

## 22. METER CALIBRATION

**All analog input and analog output ranges** of the meter have been digitally calibrated at the factory prior to shipment using calibration equipment certified to NIST standards. Calibration constants are stored digitally in non-volatile memory in EEPROM on the signal conditioner board and analog output board. This allows the boards to be changed without requiring meter recalibration. Digital calibration also eliminates much of circuitry that would be associated with analog calibration, providing superior long term accuracy and stability.

**If periodic recalibration is required**, the meter may be returned to the factory or to any authorized distributor. A modest fee will apply, which also covers a Calibration Certificate.

**DC, load cell, AC RMS, and thermocouple signal conditioner boards** can be calibrated using Instrument Setup Software running on a host PC (Section 20). An RS232, RS485, USB or Ethernet interface board must be installed in the meter for communication to the PC. This board may be removed following calibration. A certified, calibrated signal source is also required. The Calibration screen of Instrument Setup Software is accessed by clicking on Calibration at the top of the DPM Main Menu screen. The PC first recognizes the type of board, then prompts you to apply specific jumpers and specific known signals for each range. Press Repeat to take more readings. When you have decided on which reading to accept, press on the number 1 through 10 of that reading.

**The RTD/Ohms signal conditioner board** cannot be calibrated using the Calibration screen of Instrument Setup Software. Instead, use the Scaling tab under Setup. Here you can enter values for Scale and Offset for a specific range. These corrections apply to resistance, not to RTD temperature. To calibrate RTD temperature, refer to the published resistance table for your RTD type, and calibrate resistance. For example, if your measured resistances are 0.1% low, apply a scale factor of 1.01.

## 23. SPECIFICATIONS

### Meter Display

Type .....5 LED, 7-segment, 14.2mm (.56") high digits & 3 LED indicators  
Color..... Red or green  
Range..... -99999 to +99999 and -99990 to +99990

### A to D Conversion

Technique (Pat.5,262,780)..... Concurrent Slope™  
Read Rate .....60/s for 60 Hz NMR, 50/s for 50 Hz NMR  
Output Update Rate .....56/s at 60 Hz, 47/s at 50 Hz  
Display Update Rate ..... 3.5/s at 60 Hz, 3/s at 50 Hz

### Noise Rejection

CMV from DC to 60 Hz.....Withstand 250Vac  
Dielectric strength..... 3.5 kV ac for 5 sec, 2.3 kV ac for 1 min  
CMR from DC to 60 Hz ..... 130 dB  
NMR at 50/60 Hz.....90 dB with minimum digital filtering

### Control Inputs (CMOS/TTL levels, logic 0 = tied to digital ground, logic 1 = open)

/ Hold input .....Logic 0 holds display and outputs  
/ Peak or Valley input .....Logic 0 displays peak/valley value  
/ Tare input ..... Logic 0 offsets input value to zero  
/ Tare Reset.....Logic 0 resets Tare value to zero  
/ Reset input ..... Logic 0 resets all meter functions  
/ Function Reset input .....Logic 0 resets peak values and alarms  
/ Decimal Point input ..... Overrides internal DP selections and controls DP position  
/ Display Blank input.....Logic 0 shuts off the display

### Power Requirements

Input Voltage rating (standard).....85-264 Vac or 90-300 Vdc (DC range not ETL approved)  
Input Voltage rating (low voltage option) ..... 12-32 Vac or 10-48 Vdc  
Power Line Frequency ..... DC and 47-63 Hz  
Power Consumption, Max ..... 5 Watts

### Excitation Outputs

Voltage & Current Levels (jumper selectable) ..... 5 Vdc  $\pm$ 5%, 100 mA max  
10 Vdc  $\pm$ 5%, 120 mA max  
24 Vdc  $\pm$  5%, 40 mA max  
Excitation Output Ripple .....100 mVp max  
Isolation from power and outputs ..... 250 Vac  
Insulation dielectric strength to power and outputs..... 3.5 kV ac for 5 sec, 2.3 kV ac for 1 min  
Isolation to signal common..... 50 Vdc

### Maximum Applied Voltage Signals

Voltage input ranges of 2V and above (AC or DC)..... 600 Vrms  
Voltage input ranges of 200 mV (AC or DC), load cell, thermocouple, RTD ..... $\pm$ 100 Vdc

### Input Types, Ranges, Resolution, Error at 25°C

### DC Volts

Range	Resol.	Resist.	Error
200.00 mV 2.0000 V 20.000 V 200.00 V	10 $\mu$ V 100 $\mu$ V 1 mV 10 mV	1 G $\Omega$ 1 G $\Omega$ 10 M $\Omega$ 10 M $\Omega$	0.01% of FS $\pm$ 2 cts
300.0 V 600.0 V*	0.1 V 0.1 V	10 M $\Omega$ 10 M $\Omega$	$\pm$ 0.4 V $\pm$ 0.4 V

### DC Amps

Range	Resol.	Resist.	Error
2.0000 mA 20.000 mA 200.00 mA	0.1 $\mu$ A 1 $\mu$ A 10 $\mu$ A	100 $\Omega$ 10 $\Omega$ 1 $\Omega$	0.01% of FS $\pm$ 2 cts
5.000 A	1 mA	0.01 $\Omega$	$\pm$ 10 mA

**True RMS Volts** (0% to 100% of Full Scale, 0 Hz and 10 Hz to 10 kHz, crest factor 3.0)

Range	Resol.	Resist.	Error
200.00 mV 2.0000 V 20.000 V 200.00 V	10 $\mu$ V 100 $\mu$ V 1 mV 10 mV	22 M $\Omega$ 22 M $\Omega$ 1 M $\Omega$ 1 M $\Omega$	0.03% of FS $\pm$ 2 cts
300.0V 600.0 V*	100 mV 100 mV	1 M $\Omega$ 1 M $\Omega$	$\pm$ 0.8 V $\pm$ 0.8 V

**True RMS Amps** (0% to 100% of Full Scale, 0 Hz and 10 Hz to 10 kHz, crest factor 3.0)

Range	Resol.	Resist.	Error
2.0000 mA 20.000 mA 200.00 mA	0.1 $\mu$ A 1 $\mu$ A 10 $\mu$ A	100 $\Omega$ 10 $\Omega$ 1 $\Omega$	0.03% of FS $\pm$ 2 cts
5.000 A	1 mA	0.01 $\Omega$	$\pm$ 20 mA

### Resistance Measurement

Range	Resolution	Error
0-20.000 $\Omega$ 0-200.00 $\Omega$ 0-2000.0 $\Omega$ 0-20000 $\Omega$ 0-200.00 k $\Omega$	1 m $\Omega$ 10 m $\Omega$ 100 m $\Omega$ 1 $\Omega$ 10 $\Omega$	0.01% of FS $\pm$ 2 cts

### Thermocouple (0.1°, 1° resolution)

Type	Range	Error
J	-210 to 760°C -347to 1400°F	.01% FS $\pm$ 0.09°C .01% FS $\pm$ 0.16°F
K	-244 to 1372°C -408to 2501°F	.01% FS $\pm$ 0.10°C .01% FS $\pm$ 0.17°F
T	0 to 400°C -257 to 0°C	.01% FS $\pm$ 0.03°C .01% FS $\pm$ 0.20°C
	32 to 752°F -430 to 32°F	.01% FS $\pm$ 0.05°F .01% FS $\pm$ 0.36°F
E	-240 to 1000°C -400 to 1830°F	.01% FS $\pm$ 0.18°C .01% FS $\pm$ 0.32°F
N	-245 to 1300°C -410 to 2370°F	.01% FS $\pm$ 0.10°C .01% FS $\pm$ 0.17°F
S	-46 to +1768°C -51 to +3213°F	.01% FS $\pm$ 0.12°C .01% FS $\pm$ 0.22°F
R	-45 to 1768°C -49 to 3214°F	.01% FS $\pm$ 0.17°C .01% FS $\pm$ 0.31°F

### RTD (0.01°, 0.1°, 1° resolution)

Type	Range	Error
Pt 100 $\Omega$ .00385	-202 to 850°C -331 to 1562°F	.01% FS $\pm$ 0.03°C .01% FS $\pm$ 0.05°F
Pt 100 $\Omega$ .003925	-202 to 631°C -331 to 1168°F	.01% FS $\pm$ 0.04°C .01% FS $\pm$ 0.07°F
Ni 120 $\Omega$ .00672	-80 to 260°C -112 to 500°F	.01% FS $\pm$ 0.05°C .01% FS $\pm$ 0.09°F
Cu 10 $\Omega$ .00427	-97 to 260°C -143 to 500°F	.01% FS $\pm$ 0.05°C .01% FS $\pm$ 0.09°F

### Ratio, Potentiometer Follower, Strain

Range	Resol.	Resistance	Error
200.00 mV 2.0000 V 20.000 V	10 $\mu$ V 100 $\mu$ V 1 mV	1 G $\Omega$ 1 G $\Omega$ 1 M $\Omega$	0.01% of FS $\pm$ 2 cts

\* 600V ranges are not ETL certified.



## Load Cell Input

Range	Resolution	Resistance	Zero Range	Span Range	Error
20.000 mV	1 $\mu$ V	1 G $\Omega$	-99999 to 99999	0 to $\pm$ 99,999	0.01% of FS $\pm$ 2 cts
50.000 mV	2.5 $\mu$ V				
100.00 mV	5 $\mu$ V				
250.00 mV	12.5 $\mu$ V				
500.00 mV	25 $\mu$ V				

## Thermocouple Accuracy

Span Tempco	0.003% of reading/ $^{\circ}$ C 0.0015% of reading/ $^{\circ}$ C for load cell meter
Zero Tempco	0.2 $\mu$ V/ $^{\circ}$ C
Reference Junction Accuracy	1 $^{\circ}$ C, 10 $^{\circ}$ C to 40 $^{\circ}$ C

## Dual & Quad Relay Options

Power to Relay Option	Powered by meter
Setpoint Setup	Via front panel pushbuttons or RS232/485
Update Rate	56/s at 60 Hz, 47/s at 50 Hz
Response to input signal (min)	Display update rate
Input Signal (selectable)	Filtered or unfiltered input signal
Actuation Modes (selectable)	Above or below setpoint, latching or non-latching, disabled
Output Time Delay (selectable)	1 to 128 readings
Front Panel Enable / Lockout Modes (selectable)	1) Display and change setpoints 2) Display but do not change setpoints 3) Neither display nor change setpoints
Alarm Status Indication	2 or 4 red LED lamps
Status Indication Setup (selectable)	Lit when output is ON or OFF, or disabled

### Form C, SPDT Relay Output:

AC Rating	8A @ 240 Vac
DC Rating	8A @ 24 Vdc
Isolation rating between signal common and contacts	250 Vac
Insulation dielectric strength between signal common and contacts	3.5 kV ac for 5 sec, 2.3 kV ac for 1 min

### Form A, SPST Solid State Relay Output:

AC Rating	120 mA @ 140 Vac
DC Rating	120 mA @ 180 Vdc
Isolation rating between signal common and contacts	250V ac
Insulation dielectric strength between signal common and contacts	3.5 kV ac for 5 sec, 2.3 kV ac for 1 min

## Analog Output Option

Power to Analog Output Option	Powered by meter
Output Levels	0-20 mA, 4-20 mA, 0-10V, -10 to +10V
Voltage Compliance, 0-20 mA Output	12V (0-600 Ohm load)
Current Compliance, 0-10V, -10 to +10V Output	2 mA (5 kOhm or higher load)
Accuracy	Meter input accuracy $\pm$ 0.02% of full scale analog output
Resolution	16 bit (1 part in 65,536)

Response Time ..... 50/60Hz update rate  
 Scaling of Reading for Zero Output.....-99,999 to +99,999  
 Scaling of Reading for Full Scale Output..... -99,999 to +99,999  
 Isolation rating between signal common and analog output..... 250V ac  
 Insulation dielectric strength between signal common and analog output.....  
 ..... 3.5 kV ac for 5 sec, 2.3 kV ac for 1 min

**Serial Interface Option (USB, RS232, RS485, RS485-Modbus boards)**

Output Types.....RS232, RS485, RS485-Modbus, USB  
 ..... USB-to-RS485 converter, Ethernet, Ethernet-to-RS485 converter  
 Power to Interface Option.....Powered by meter  
 RS485 Wiring ..... Half or full duplex  
 Baud Rates ..... 300, 600, 1200, 2400, 4800, 9600, 19200  
 Serial Protocols ..... Custom ASCII, Modbus RTU, Modbus ASCII (selectable)  
 Signal Levels ..... Meet RS232, RS485, USB, Ethernet standards  
 Isolation rating between signal common and serial I/O ..... 250V ac  
 Insulation dielectric strength between signal common and serial I/O .....  
 ..... 3.5 kV ac for 5 sec, 2.3 kV ac for 1 min

**Option Board Connectors:**

RS232 ..... Single RJ11 jack  
 RS485 ..... Two RJ11 jacks (for daisy chaining with 6-wire data cables)  
 RS485 Modbus..... Two RJ45 jacks (for daisy chaining with 8-wire data cables)  
 USB..... USB type B plug  
 USB-to-RS485 converter.....USB type B plug plus RJ11 jack to RS485 bus  
 Ethernet..... Single RJ45 to Ethernet  
 Ethernet-to-RS485 converter.....RJ45 jack to Ethernet plus RJ11 jack to RS485 bus

**Environmental**

Operating Temperature .....0°C to 55°C  
 Storage Temperature ..... -40°C to 85°C  
 Relative Humidity ..... 95% from 0°C to 40°C, non-condensing  
 Case..... NEMA-4X (IP65) from front when panel mounted (not verified for UL)  
 Shock ..... 10 G at 1 kHz, applied in X, Y, Z axes  
 Vibration ..... 15 Hz to 150 Hz, 1 mm to 2 mm amplitude, 20 G max.

## 24. GLOSSARY OF TERMS

### Adaptive Filter Threshold

A threshold which causes an adaptive moving average filter to be reset to the latest reading when the accumulated difference between individual readings and the filtered reading exceeds that threshold. Adaptive moving average filtering allows a meter to respond rapidly to actual changes in signal while filtering out normal noise. The accumulated difference is also reset to zero when the latest reading has a different polarity than the filtered reading. A low adaptive filter threshold is normally selected. A high filter threshold should be selected if the signal has large transients.

### Alarm, Latched

An alarm which stays actuated until reset. Latched alarms can shut down machinery or a process when an operating limit has been exceeded, or maintain an alarm condition until acknowledged by an operator.

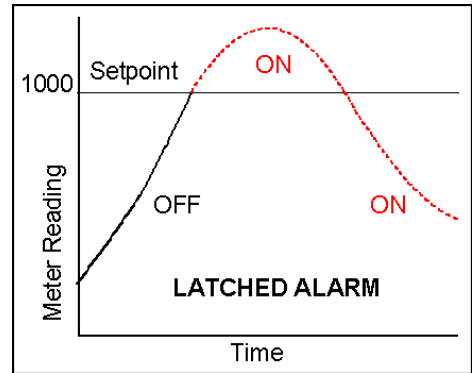

### Alarm, Non-latched

An alarm which changes state automatically when the reading rises above a specified limit and changes back automatically when the reading falls below a limit.

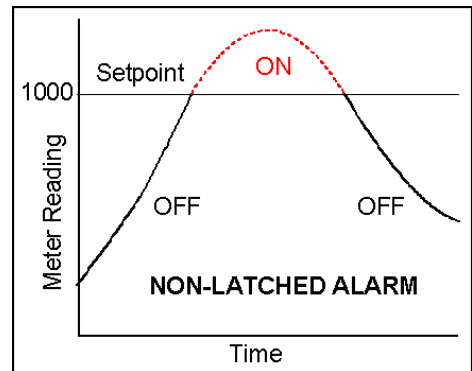

### Autofilter

A selectable digital filter mode which automatically selects an appropriate moving average filter time constant from 0.08 sec to 9.6 sec for the encountered noise condition.

### Auto-tare

A selectable meter operating mode, where the first reading following power-on or meter reset is used to zero the display. Further readings are then relative to this new zero.

### Batch Average Filter

A digital filter mode which averages 16 readings and then displays the average. Readings are taken at 60/sec with 60 Hz power and 50/sec with 50 Hz power.

### Counts

The reading displayed on the panel meter ignoring the decimal point.

### Custom ASCII Protocol

A simplified, short protocol for use with these panel meters. It allows 31 digital addresses. Not an industry-standard protocol, like the more complex *Modbus protocol*, which is also offered with the meters.

### Deviation Band

A band in counts which controls relay action symmetrically around a *setpoint*. The relay actuates when the reading falls within the

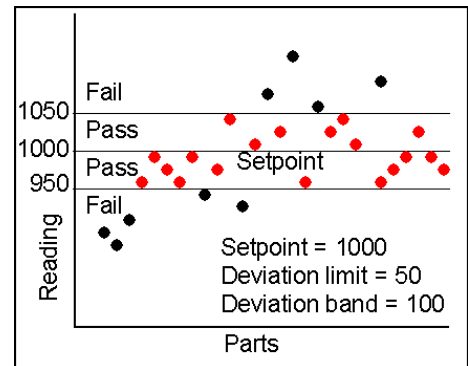

deviation band, and de-actuates when the reading falls outside. A limit (e.g., 50 counts) is set up around both sides of the setpoint to create a deviation band (e.g., 100 counts). Setting up a passband around a setpoint is often used for component testing. Deviation limits are programmed by entering menu item *dEU1b* for Alarm 1 and *dEU2b* for Alarm 2. The deviation band equals two limits.

### Display Blank

A rear panel input which blanks the display when the input is tied to logic ground by a switch or when 0V is applied (logic level true). The meter display will light when the input is open or is held at +5V (logic level false).

### Extended Meter

A digital panel meter with an enhanced firmware that provides added capabilities, namely linearization of nonlinear inputs and display of rate of change from successive readings.

### Full Scale

The maximum input signal range for which the meter has been configured. For example, the most sensitive full scale for the load cell meter is  $\pm 20$  mV (signal range from -20 mV to +20 mV).

### Function Reset

A rear panel control input which resets Peak, Valley and any latched alarms when the input is tied to logic ground by a switch or 0V is applied (logic level true). To reset the value again, the input must be open or 5V applied (logic level false) and then set low.

### Ground Loop

A closed conductive path in external ground wiring that allows stray currents to flow in ground wiring, creating ground noise. The meters in this manual minimize ground loop problems by mutually isolating the grounds associated with meter power, signal input, and all output and communication options.

### Jumper

A push-on component which provides a short between two adjacent posts on a circuit board. Jumpers are used to configure signal conditioner boards for specific signal types and full scale ranges, and to configure power supply and communications boards for various modes of operation. Unused jumpers are stored by pushing one side over an unused post.

### Hysteresis, Split

Relay operation is specified symmetrically around a setpoint. The relay closes (or opens) when the reading rises above the setpoint plus one hysteresis limit, and opens (or closes) when the reading falls below the setpoint less one hysteresis limit. A narrow hysteresis band can be used to minimize relay chatter. A wide hysteresis band can be used for control.

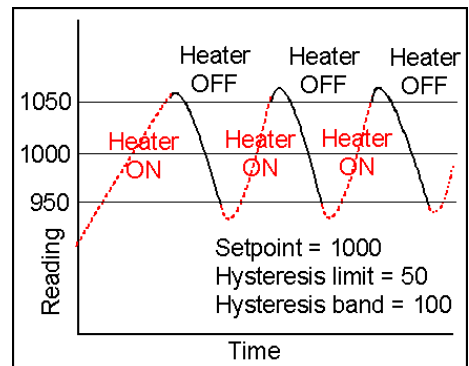

## Hysteresis, Span

Same relay operation as for split hysteresis, but specified differently. Here the setpoint is the upper control limit, and the lower control limit is the setpoint less the hysteresis band.

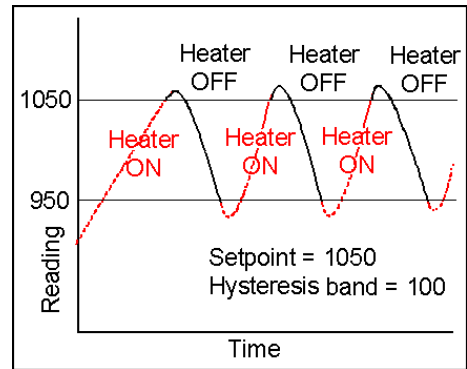

**Menu Mode** The meter programming mode used for input and range selection, meter setup, and meter configuration. Entered into from the Run mode by pressing the *MENU* key. The Menu mode can be locked out completely by a jumper.

**Meter Hold** A rear panel input which freezes the meter display and all meter outputs while that input is tied to logic ground by a switch or is held at 0V (resume operation when the input is allowed to float or is held at +5V (logic level false).

**Modbus** An industry-standard serial communications protocol which allows devices by different manufacturers to be digitally addressed by a PC on the same communication line, with up to 247 digital addresses. More complex than the *Custom ASCII* protocol, which is also supported by these meters.

## Moving Average Filter

A digital filter mode which displays a weighting moving average of readings. Readings are taken at 60/sec with 60 Hz power and 50/sec with 50 Hz power. Display update rates remain 3.5/sec with 60 Hz power and 3.0/sec with 50 Hz power. There are eight moving average modes:

- Old average x 1/2 + new reading x 1/2 (equivalent to 0.08 sec RC time constant).
- Old average x 3/4 + new reading x 1/4 (equivalent to 0.15 sec RC time constant).
- Old average x 7/8 + new reading x 1/8 (equivalent to 0.3 sec RC time constant).
- Old average x 15/16 + new reading x 1/16 (equivalent to 0.6 sec RC time constant).
- Old average x 31/32 + new reading x 1/32 (equivalent to 1.2 sec RC time constant).
- Old average x 63/64 + new reading x 1/64 (equivalent to 2.4 sec RC time constant).
- Old avg. x 127/128 + new reading x 1/128 (equivalent to 4.8 sec RC time constant).
- Old avg. x 255/256 + new reading x 1/256 (equivalent to 9.6 sec RC time constant).

**Offset** A constant adder used for the displayed reading. This is the term *b* in the straight line formula  $y = mx + b$ , where *y* is the displayed reading in counts, *m* is the scale factor, *x* is the measured reading in counts, and *b* is the offset. For direct readout in (milli)volts or (milli)amps, *offset* is 0.

**Peak Display** The maximum (or most positive) reading since that maximum was last reset. Reset can be via the meter front panel, an external input, or a software command. The displayed value can reflect the filtered or unfiltered readings.

**Process Signal** A signal whose display requires setup of *scale* and *offset* settings for display in engineering units. A classical process signal is 4-20 mA, where the 4 mA and 20 mA end points can each correspond to a desired meter reading.

## Rate of Change Meter

A configuration mode of the *Extended meter* which allows the display of rate based on successive readings. The conversion to engineering units is achieved with the combination of a multiplier from 0.1 to 10,000 and a scale factor.

**Reading** The value displayed by the meter. "Taking a reading" is the action of the meter to make an analog-to-digital conversion. Readings are taken at 60/sec with 60 Hz power or 50/sec with 50 Hz power, and are displayed with an update rate of 3.5/sec with 60 Hz power or 3.0/sec with 50 Hz power.

**Remote Display** A display mode which allows the meter to serve as a remote display to another meter when connected to it by a 4-wire phone cord. Also allows the meter to transmit raw measurement data to a computer and then display processed data from the computer. A serial communications option board is required in the meter. If such a board is not installed or no serial data is received, the meter displays *rESET*.

**Reset** There are three types of Reset:

- Peak and Valley Reset. Achieved by simultaneously pressing the *RESET* and *PEAK* keys.
- Latched Alarm Reset. Achieved by simultaneously pressing the *RESET* and *ALARMS* keys.
- Meter Reset. Causes the meter to reinitialize and take a tare reading when set up for *auto-tare*. Achieved powering up the meter, by pressing the *RESET* and *MENU* keys simultaneously, stepping through all top-level menu choices, grounding a rear panel connector, or supplying an ASCII command. *rESET* is displayed briefly.

**RS485 Half Duplex** Serial communications implemented with two wires, allowing data transmission in both directions, but not simultaneously.

**RS485 Full Duplex** Serial communications implemented with four wires, allowing data transmission in two directions simultaneously.

**Run Mode** The normal operating mode of the meter, where readings are taken, as opposed to the *menu mode*.

**Scale** A constant multiplier used to go from A/D converter counts to displayed counts. This is the slope term  $m$  in the straight line formula  $y = mx + b$ , where  $y$  is the displayed reading in counts,  $m$  is the scale factor,  $x$  is the measured reading in counts, and  $b$  is the offset. For direct readout in (milli)volts or (milli)amps, scale is 1.

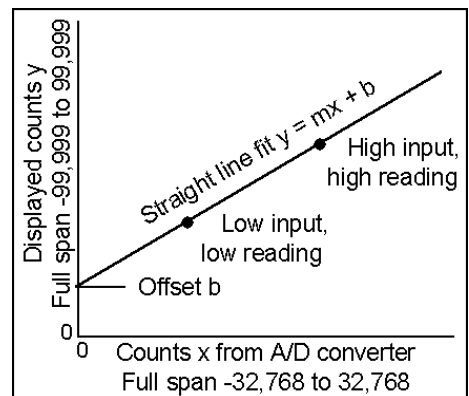

**Scaling** The process of setting *scale* and *offset* so that the meter reads properly in engineering units (such as psi).

**Scaling, Coordinates of 2 Points Method** A scaling method where four numbers are entered manually: low input, desired reading at low input; high input, and desired reading at high input. The meter then applies a straight line fit. The decimal point is set by the separate *dEC.Pt* menu item.

### **Scaling, Scale and Offset Method**

A scaling method where *scale* and *offset* are entered manually.

### **Scaling, Reading Coordinates of 2 Points Method**

A scaling method, where the low and high input values are determined from actual signals. A known low signal is first applied to the meter. That signal is captured as the low input value, and the desired low reading is entered. A known high signal is then applied. That signal is captured as the high input value, and the desired high reading is entered. The meter then applies straight line fit. This scaling method has the advantage of calibrating the transducer and meter as a system. The actual voltage or current at either point does not need to be known. The decimal point is set by the separate *dEC.Pt* menu item.

### **Setpoint**

A value compared to the reading to determine the state of a relay. Term often used interchangeably with “alarm setpoint.” The relay action can be *latching* or *non-latching*, utilize a *hysteresis band*, or utilize a *deviation band*. Hysteresis bands and deviation bands are specified by two symmetrical limits around the *setpoint*.

### **Span**

The number of *counts* corresponding to a given signal range.

### **Tare**

A rear panel input which causes the display to be set to zero when the input is momentarily tied to logic ground by a switch or is held at 0V (logic level true). When the input is allowed to float or is held at +5V (logic level false), the meter displays readings relative to this new zero. A common application is in weighing, where an external Tare button is pressed to read the weight of an empty scale (tare), and tare is then automatically subtracted as a constant from gross weight for display of net weight. Tare can also be used for other applications where a reading relative to starting point is desired.

### **Valley Display**

The minimum (or most negative) reading since that minimum was last reset. Reset can be via the meter front panel, an external input, or a software command. The displayed value can reflect the filtered or unfiltered readings.

### **Zero**

When used with process meters, *zero* is an adjustment so that a given low transducer output reads zero on the meter. *Zero* is adjusted by programming *offset*.

## 26. WARRANTY

**Yokogawa Corporation of America** warrants its products against defects in materials or workmanship for a period of one year from the date of purchase.

In the event of a defect during the warranty period, the unit should be returned, freight prepaid (and all duties and taxes) by the Buyer, to the authorized Yokogawa distributor where the unit was purchased. The distributor, at its option, will repair or replace the defective unit. The unit will be returned to the buyer with freight charges prepaid by the distributor.

### **LIMITATION OF WARRANTY**

The foregoing warranty shall not apply to defects resulting from:

1. Improper or inadequate maintenance by Buyer.
2. Unauthorized modification or misuse.
3. Operation outside the environmental specifications of the product.
4. Mishandling or abuse.

The warranty set forth above is exclusive and no other warranty, whether written or oral, is expressed or implied. Yokogawa specifically disclaims the implied warranties of merchantability and fitness for a particular purpose.

### **EXCLUSIVE REMEDIES**

The remedies provided herein are Buyer's sole and exclusive remedies. In no event shall Yokogawa be liable for direct, indirect, incidental or consequential damages (including loss of profits) whether based on contract, tort, or any other legal theory.